



ᐅᖃᐅᓯᖃᖃ ᖃᐅᓴᓴᖃᖃ

ᐅᓴᓴᖃ:

ᐅᓴᓴᖃᖃ ᖃᐅᓴᓴᖃᖃ ᖃᐅᓴᓴᖃᖃ 2



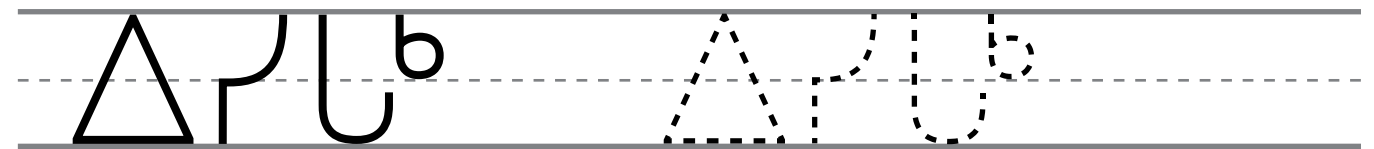
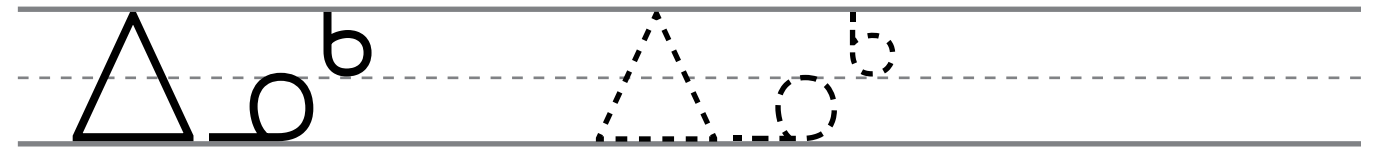
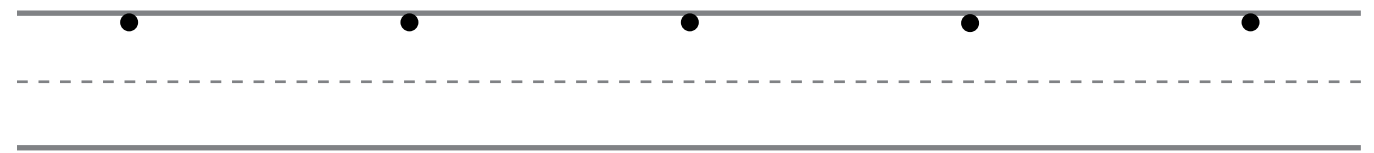
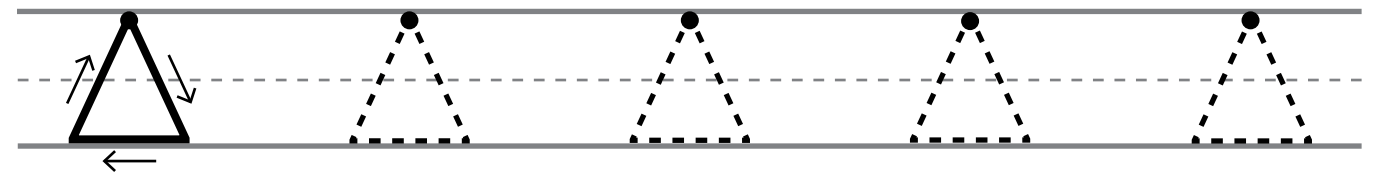
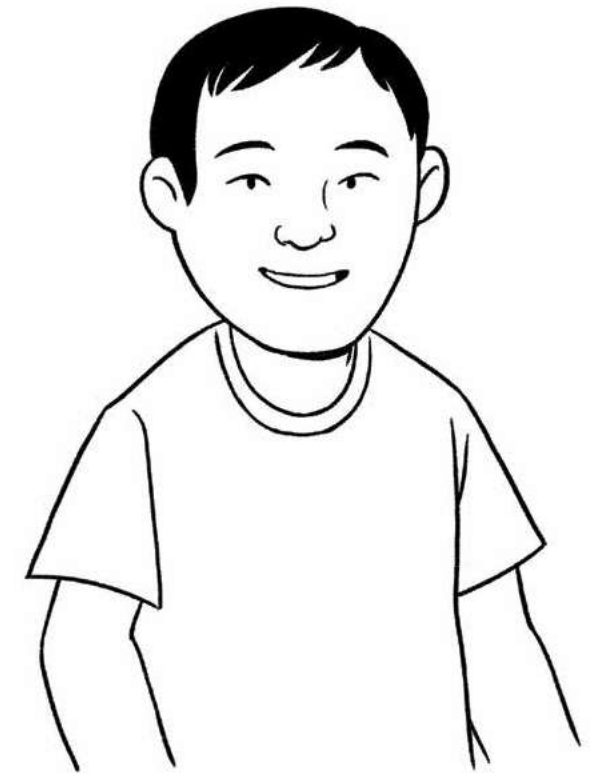
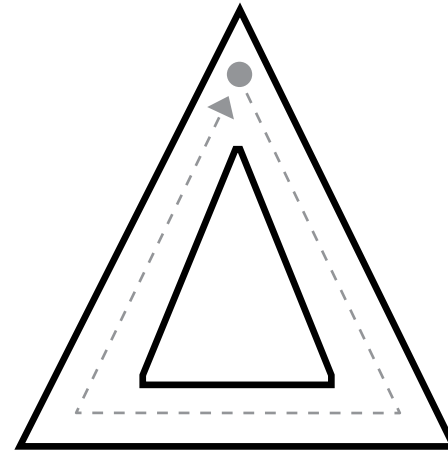

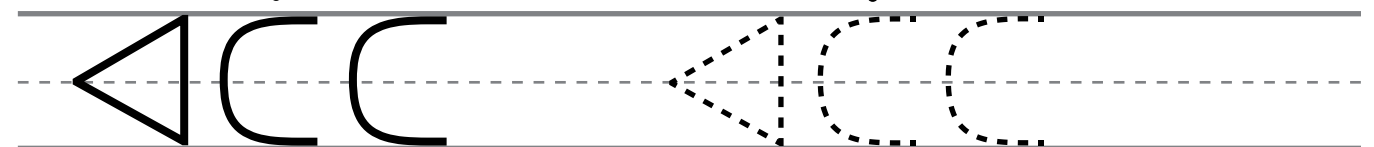
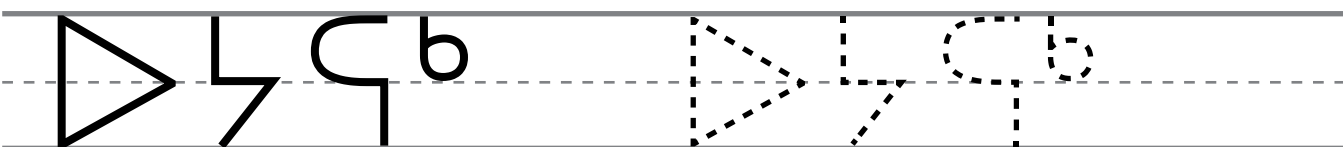
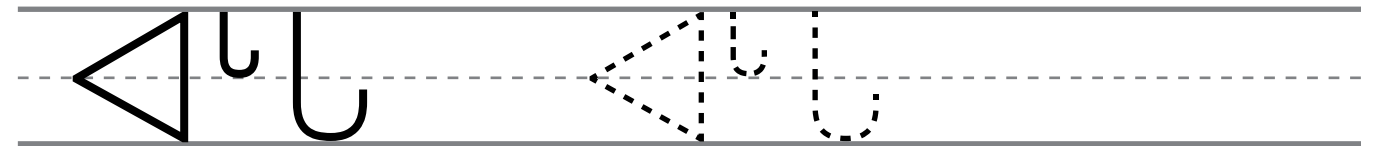
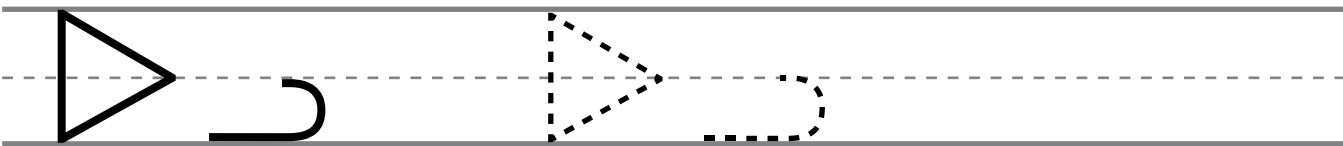
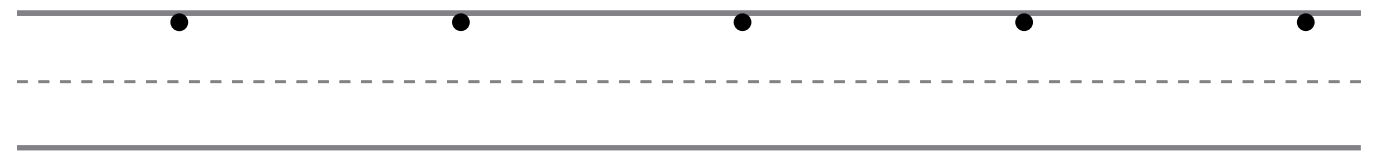
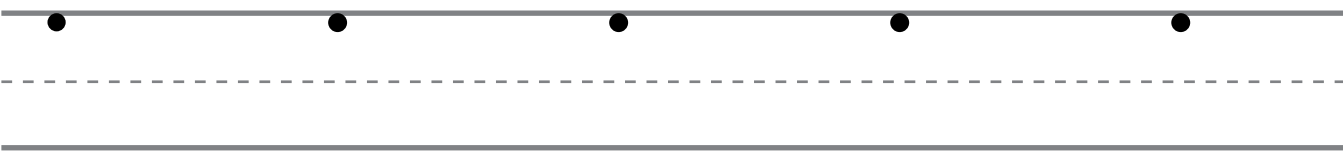
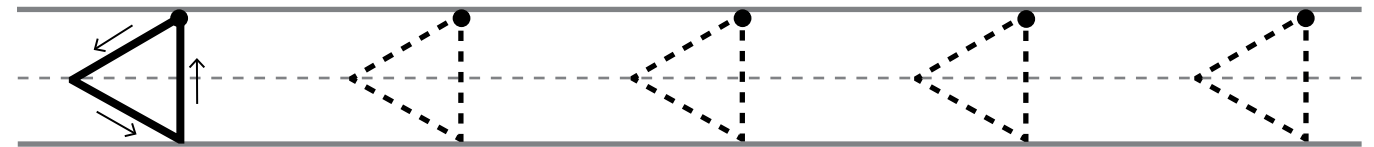
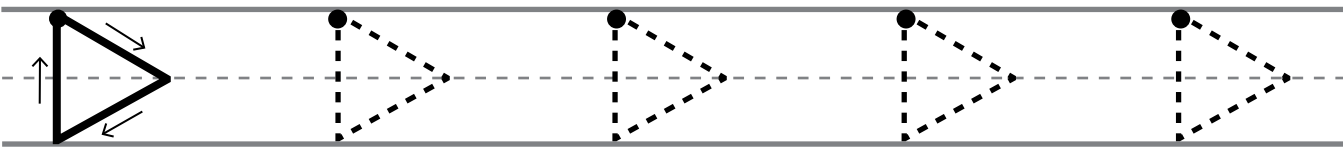
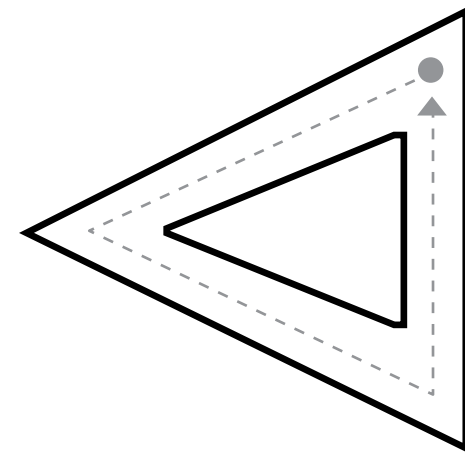
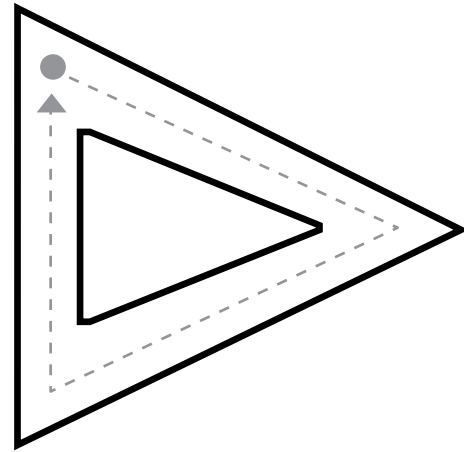
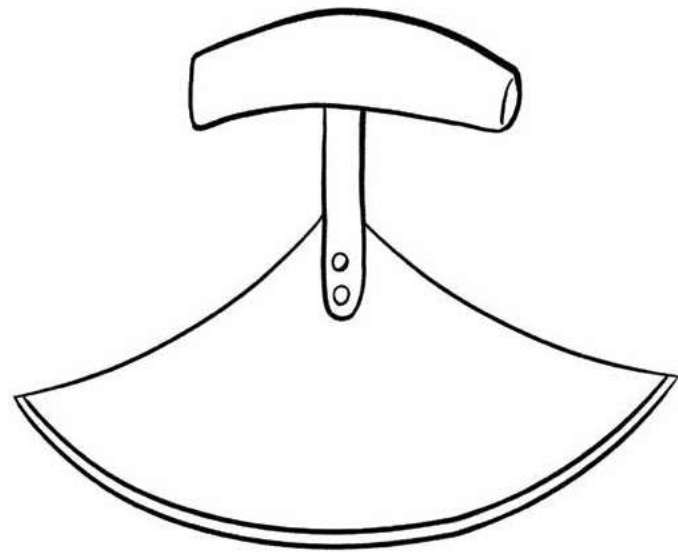

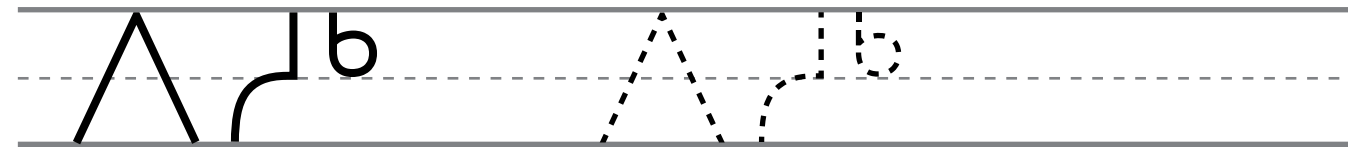
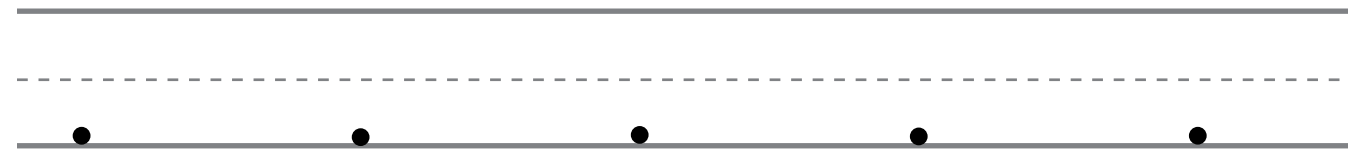
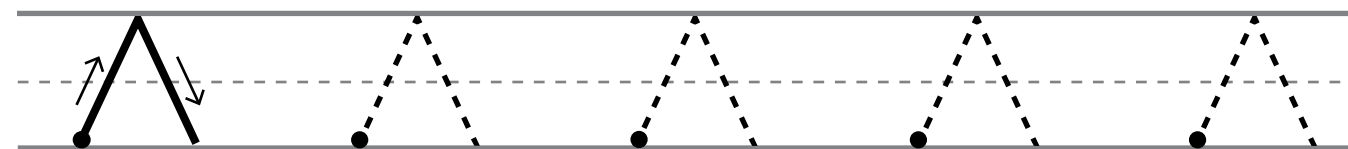
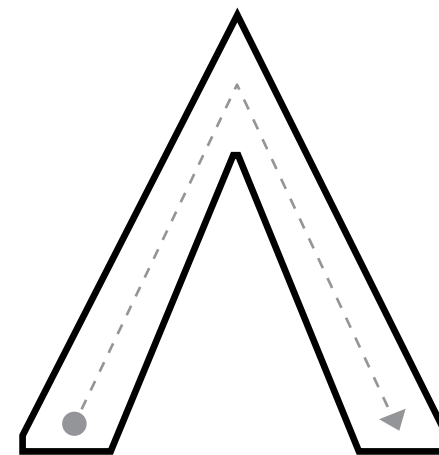
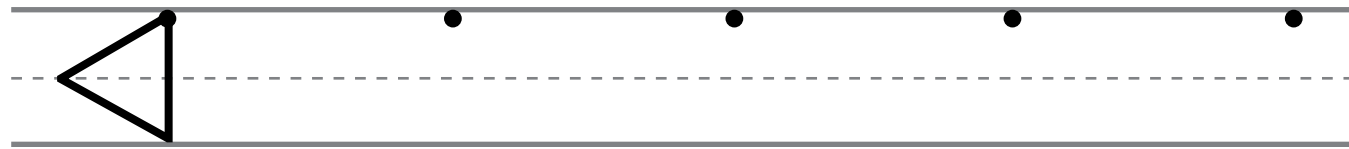
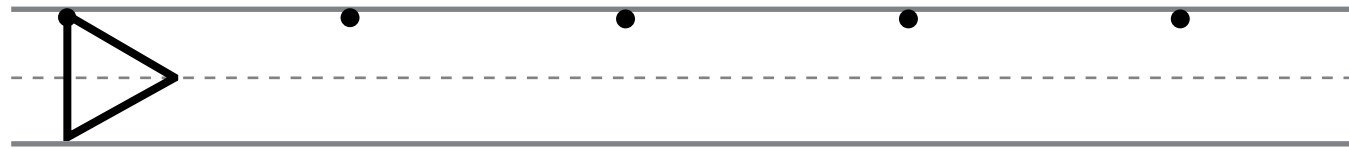
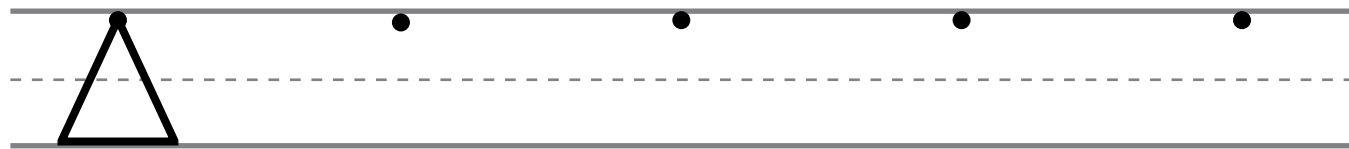
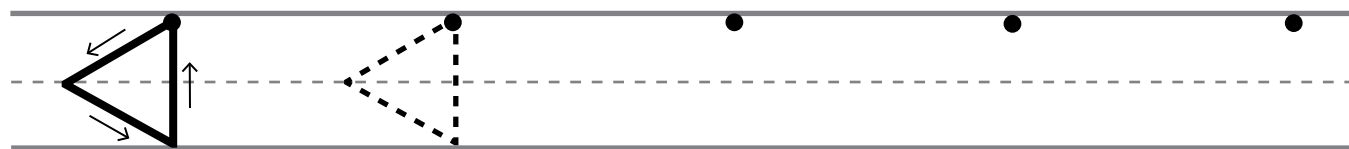
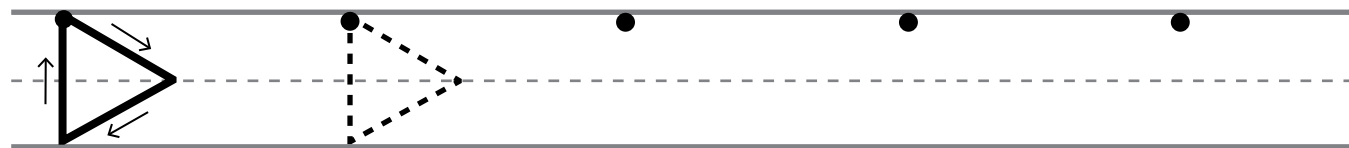
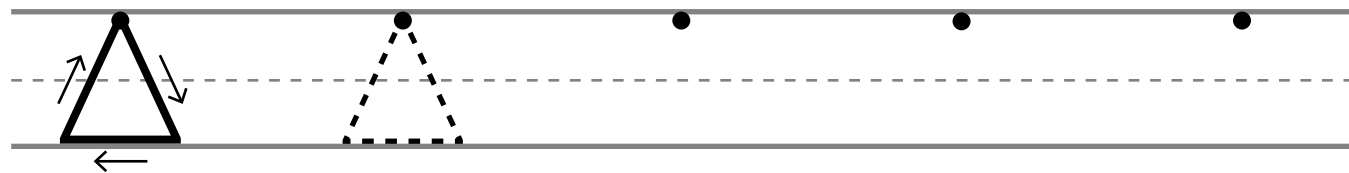
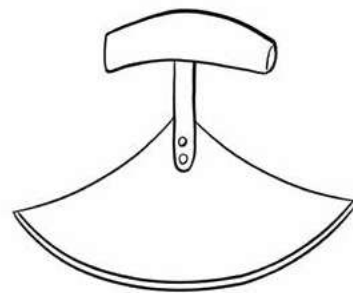
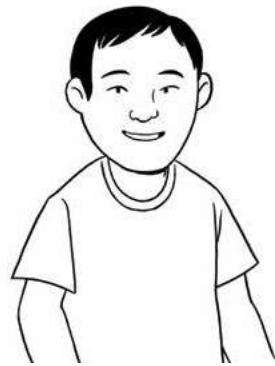

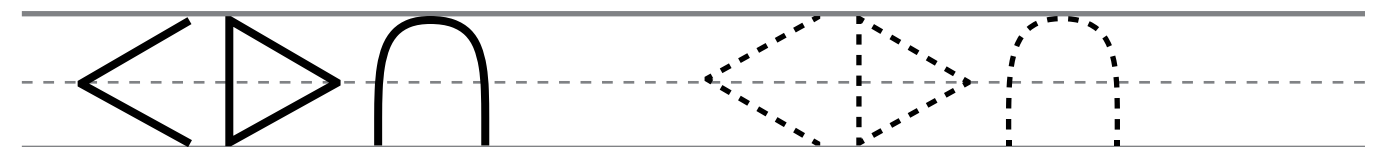
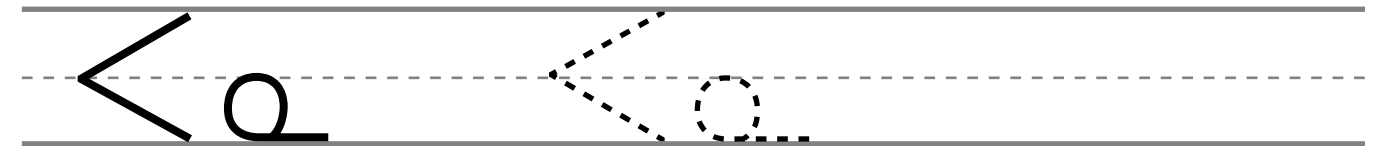
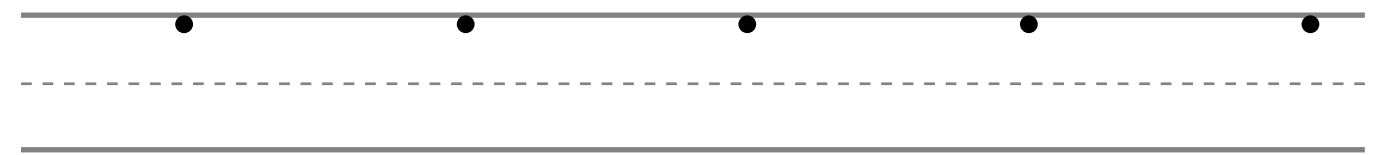
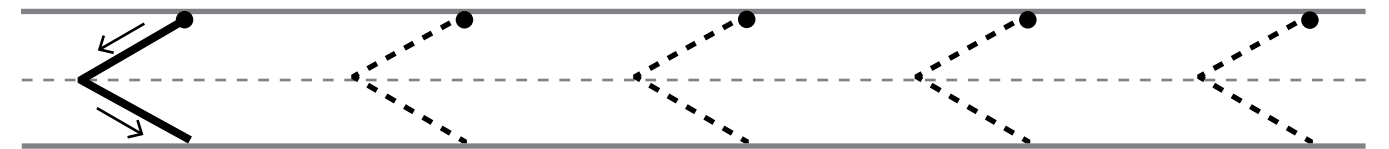
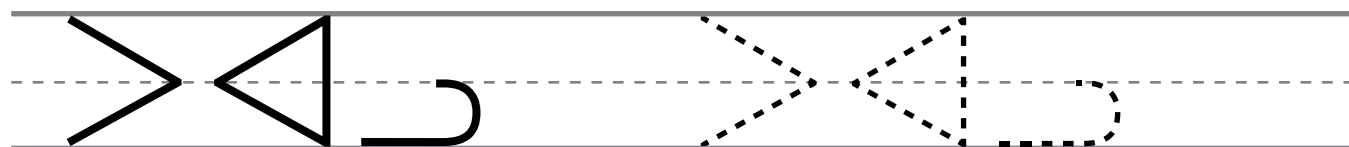
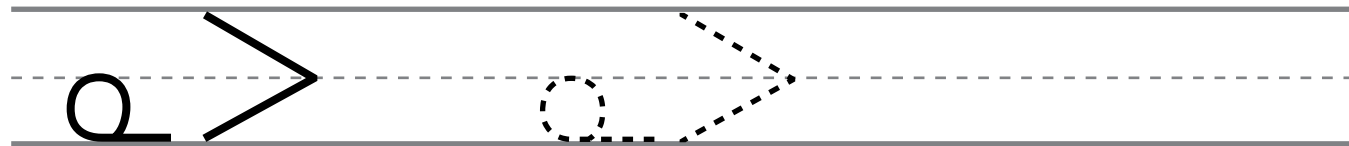
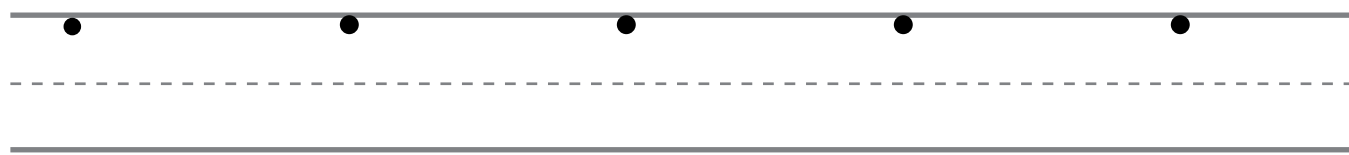
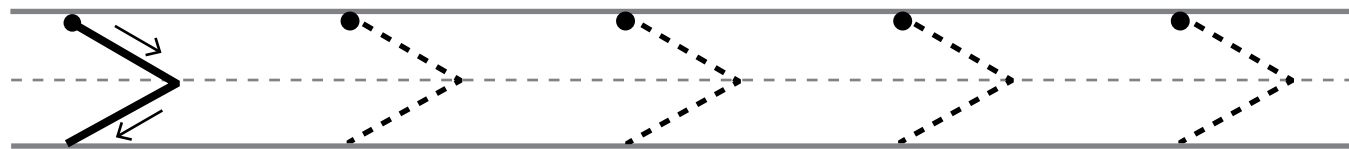
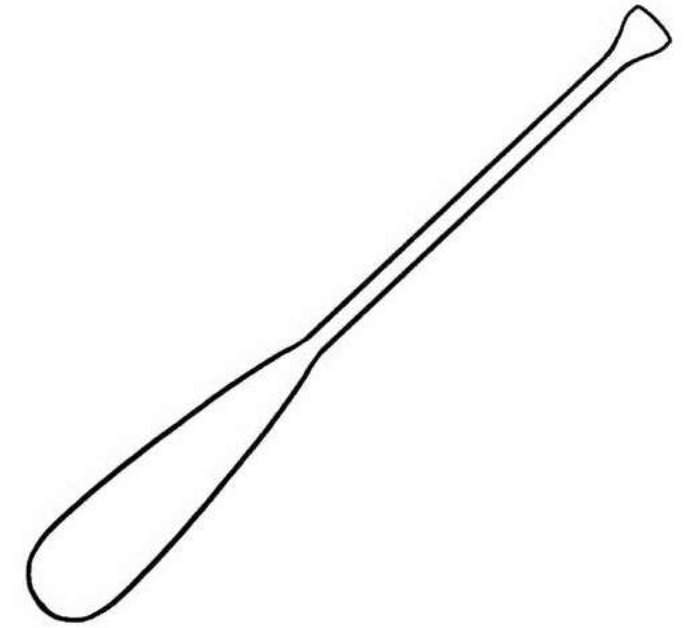
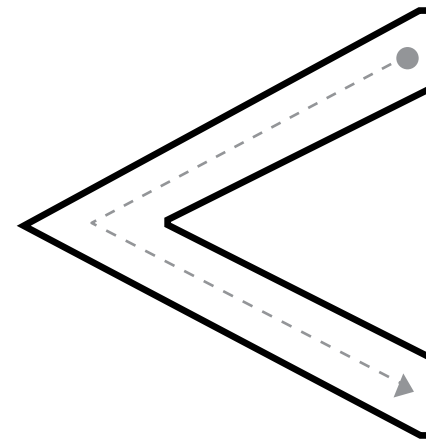
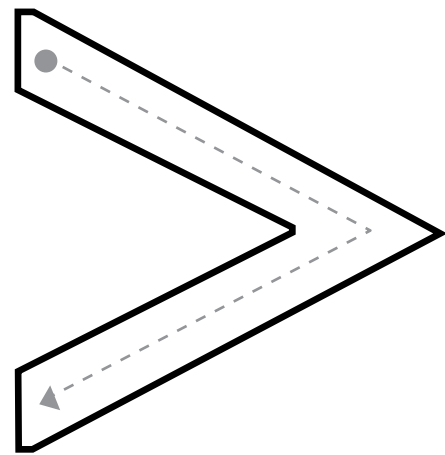
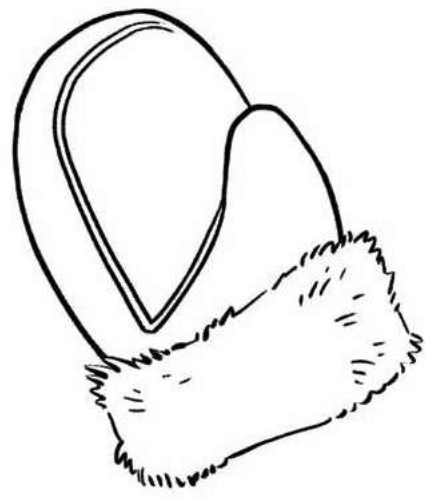

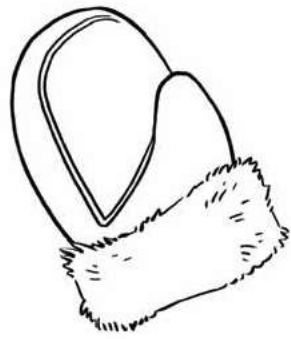

Handwriting practice for the letter 'A' on a three-line grid. The first row shows a solid 'A' with stroke order arrows, followed by a dashed 'A' for tracing, and then five dots on the baseline for independent practice. The second row shows a solid 'A' with stroke order arrows, followed by a dashed 'A' for tracing, and then five dots on the baseline. The third row shows a solid 'A' with stroke order arrows, followed by a dashed 'A' for tracing, and then five dots on the baseline. The fourth row shows a solid 'A' with stroke order arrows, followed by a dashed 'A' for tracing, and then five dots on the baseline. The fifth row shows a solid 'A' with stroke order arrows, followed by a dashed 'A' for tracing, and then five dots on the baseline. The sixth row shows a solid 'A' with stroke order arrows, followed by a dashed 'A' for tracing, and then five dots on the baseline. The seventh row shows a solid 'A' with stroke order arrows, followed by a dashed 'A' for tracing, and then five dots on the baseline. The eighth row shows a solid 'A' with stroke order arrows, followed by a dashed 'A' for tracing, and then five dots on the baseline.

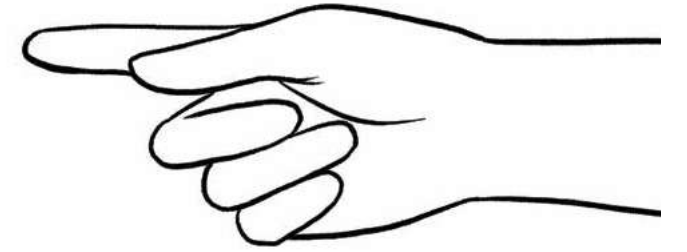
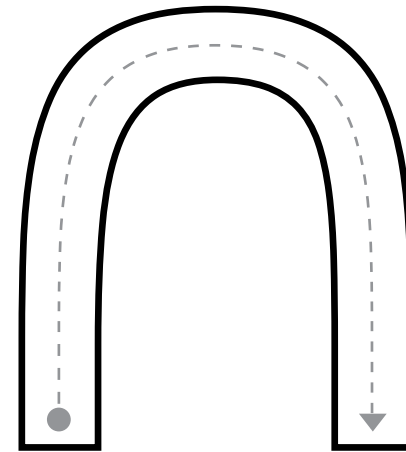

Handwriting practice for the letter 'U' on a three-line grid. The first row shows a solid 'U' with stroke order arrows, followed by four dashed 'U's for tracing, and then five dots on the baseline. The second row shows five dots on the baseline. The third row shows a solid 'U' with stroke order arrows, followed by a dashed 'U' for tracing, and then five dots on the baseline. The fourth row shows a solid 'U' with stroke order arrows, followed by a dashed 'U' for tracing, and then five dots on the baseline.

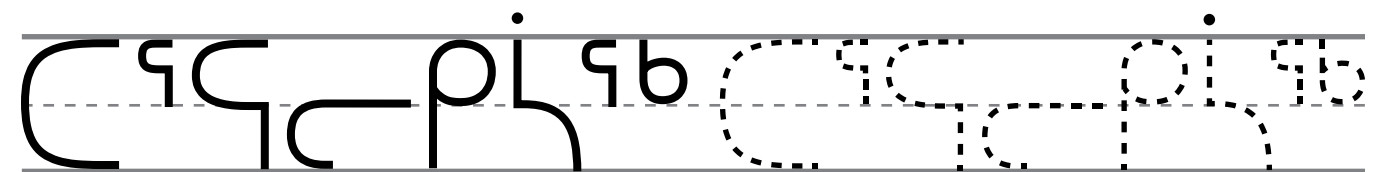
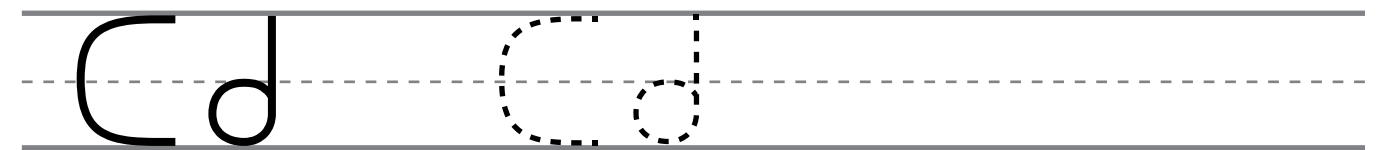
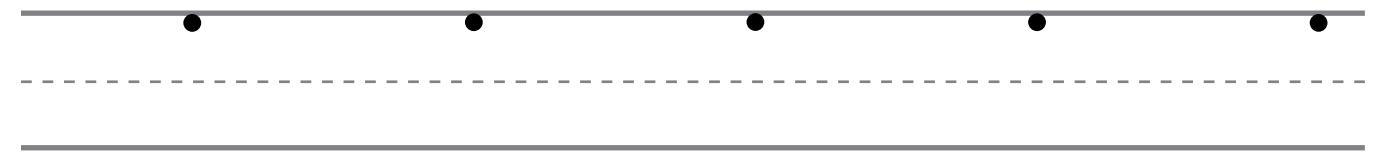
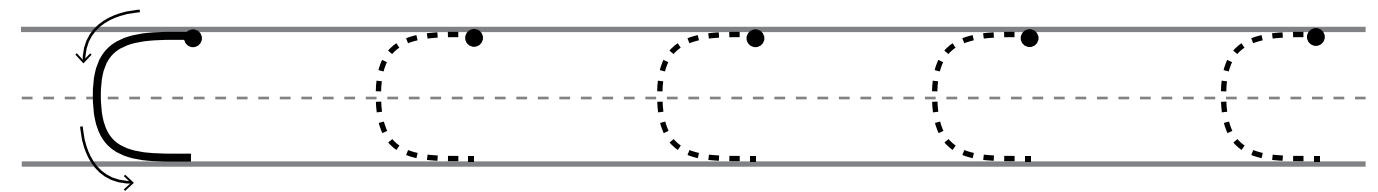
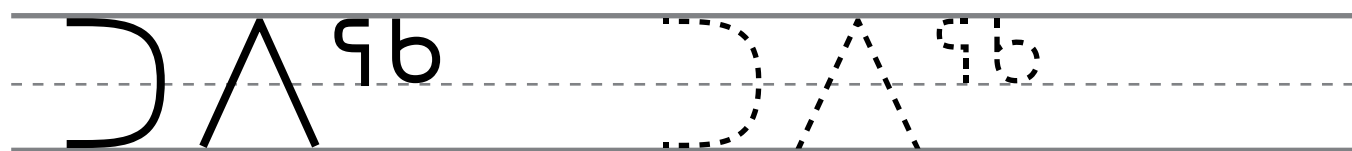
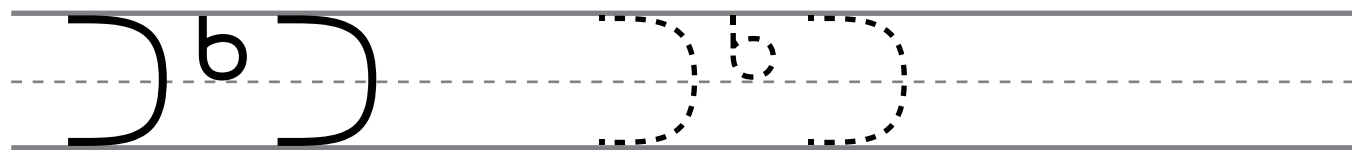
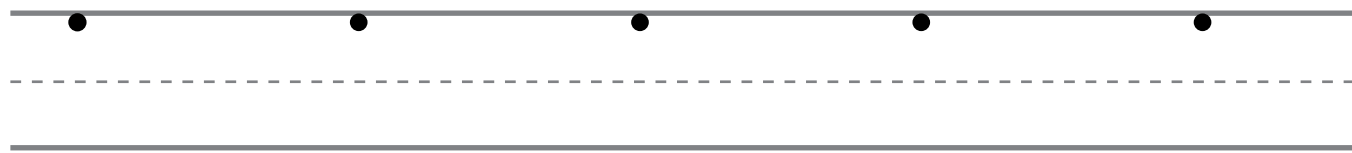
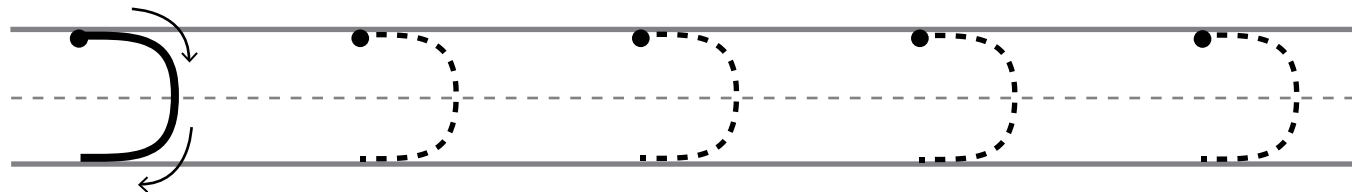
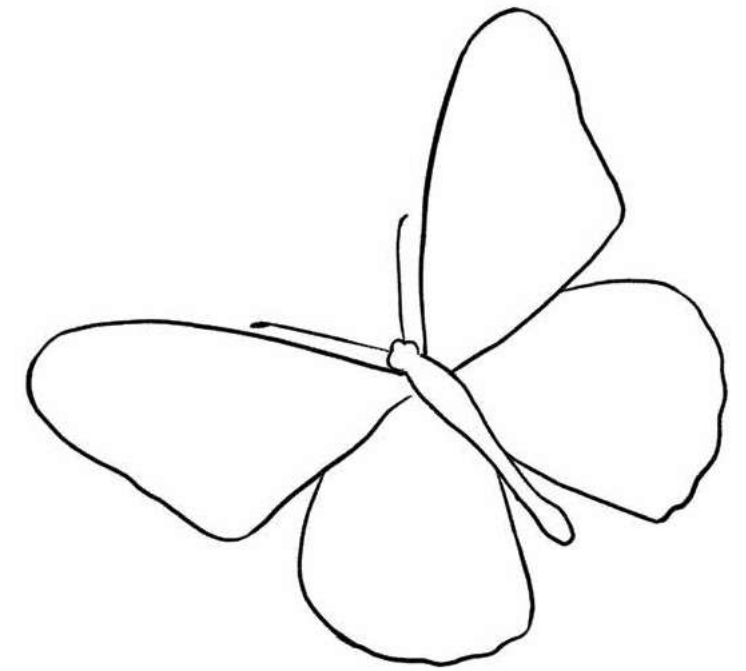
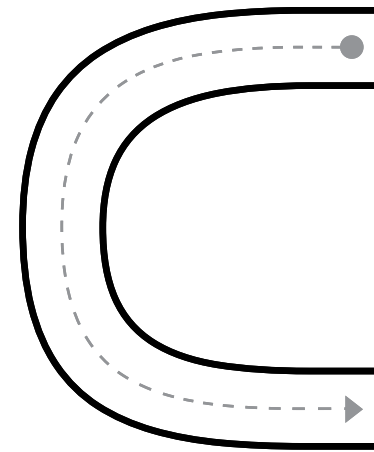
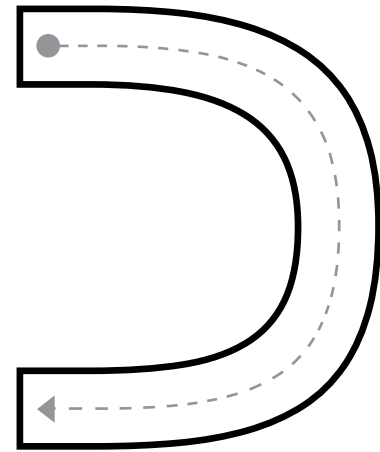
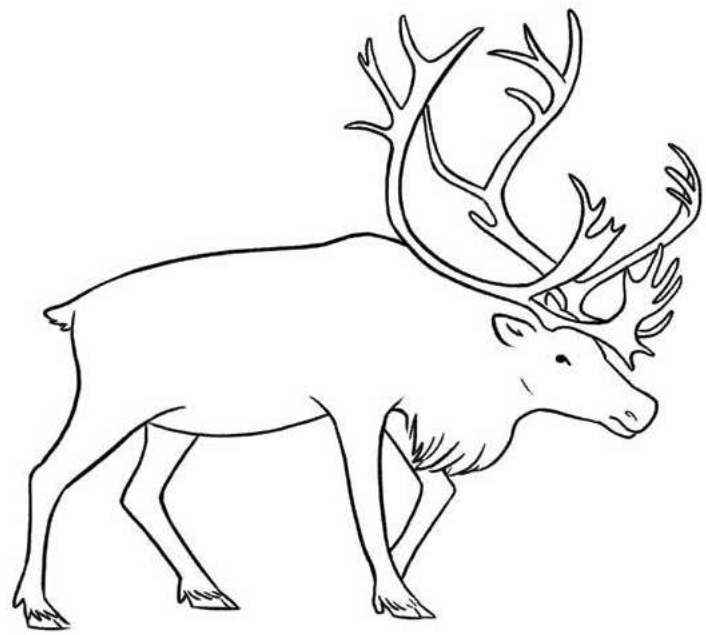

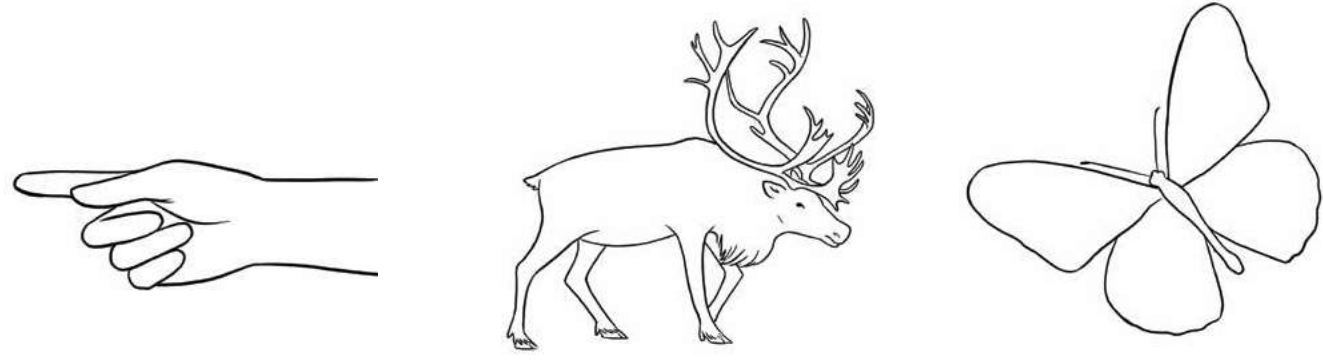

Handwriting practice for uppercase letters U, V, C, and W. Each letter is shown on a set of three horizontal lines (top, middle-dashed, bottom). The first row shows 'U' with a starting dot and a curved arrow indicating the stroke direction. The second row shows 'V' with a starting dot and two curved arrows. The third row shows 'C' with a starting dot and a curved arrow. The fourth row shows 'W' with a starting dot and three curved arrows. Each letter is followed by a dashed version for tracing and then a solid version with a starting dot for independent practice.

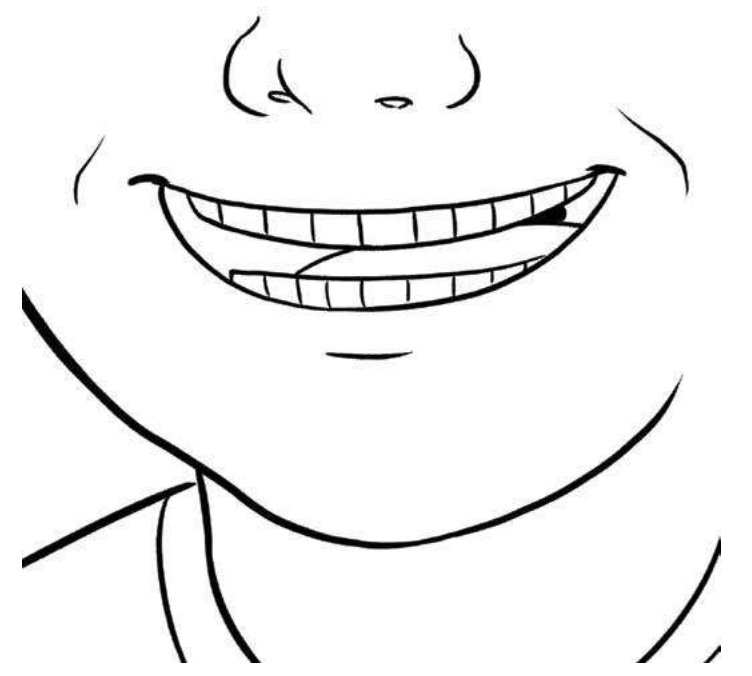
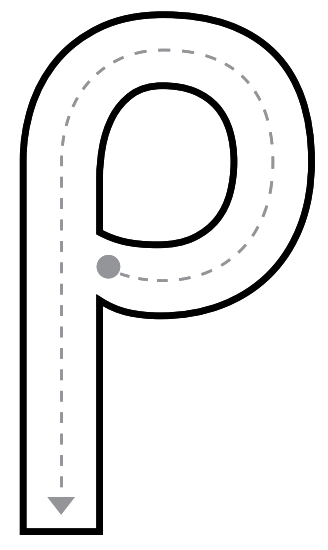

Handwriting practice for lowercase letter p and uppercase letter P. The first row shows 'p' with a starting dot on the middle dashed line and a curved arrow showing the stroke direction. This is followed by four dashed 'p's for tracing. The second row shows five starting dots on the middle dashed line. The third row shows 'P' with a starting dot on the top line and a curved arrow showing the stroke direction, followed by a dashed 'P' for tracing. The fourth row shows five starting dots on the top line. The fifth row shows 'p' followed by a triangle pointing right, then a dashed 'p' followed by a dashed triangle pointing right. The sixth row shows 'P' followed by a triangle pointing right, then a dashed 'P' followed by a dashed triangle pointing right.

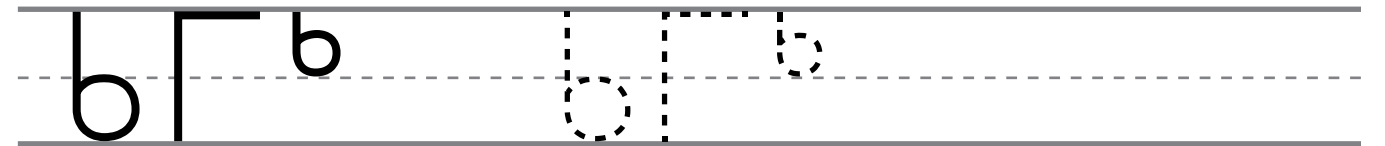
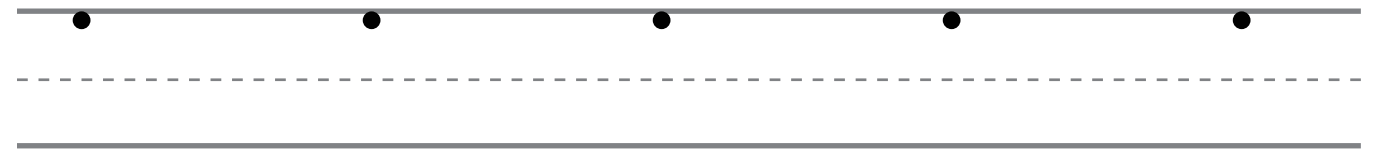
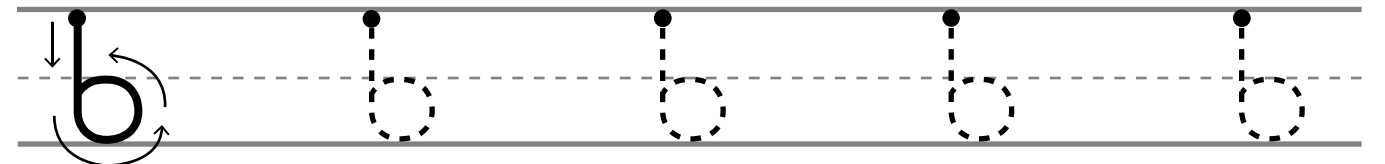
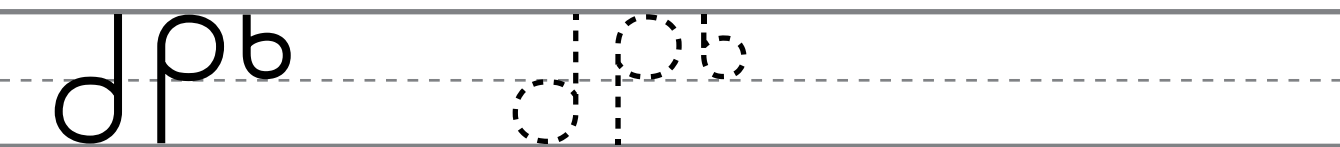
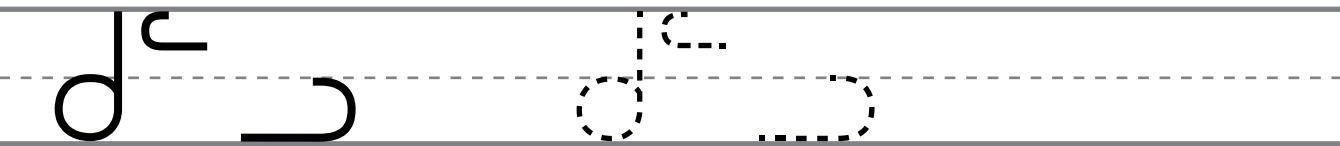
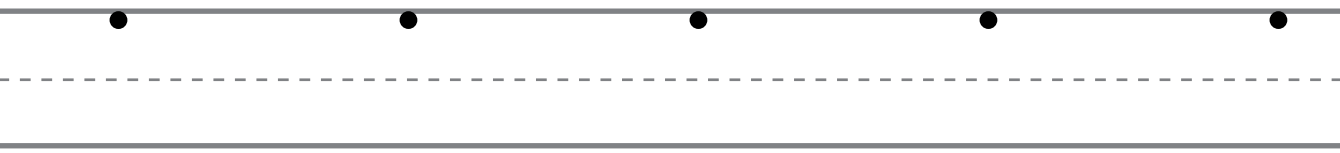
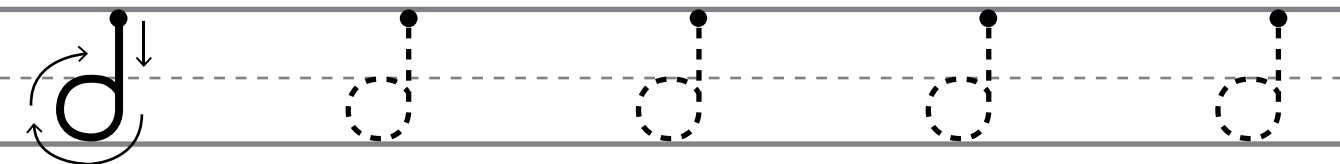
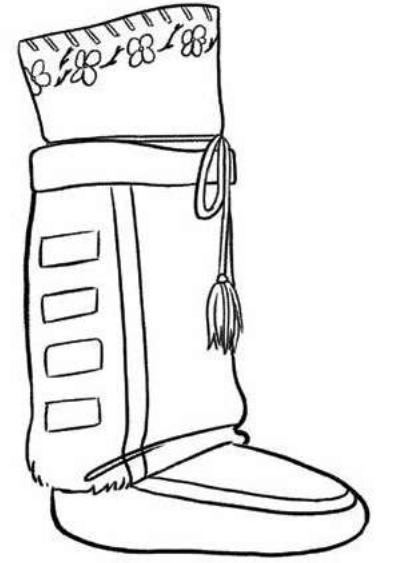
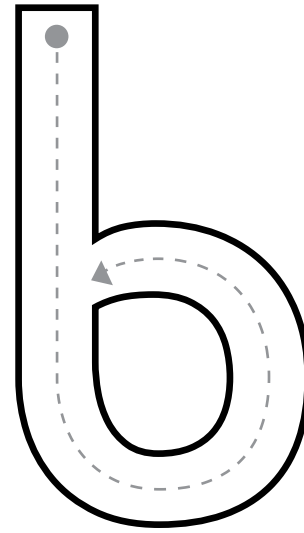
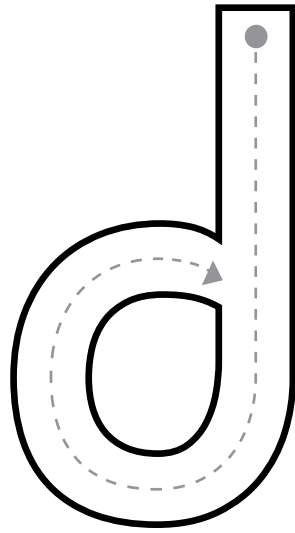
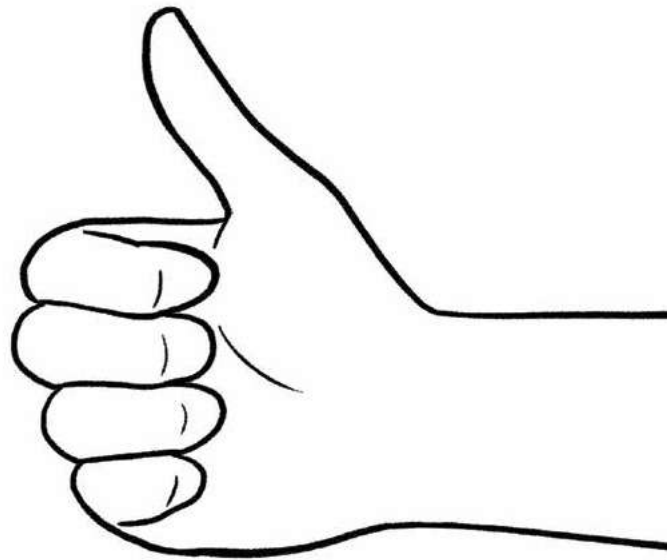

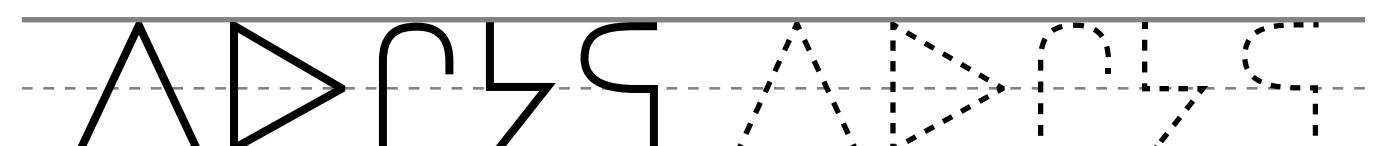
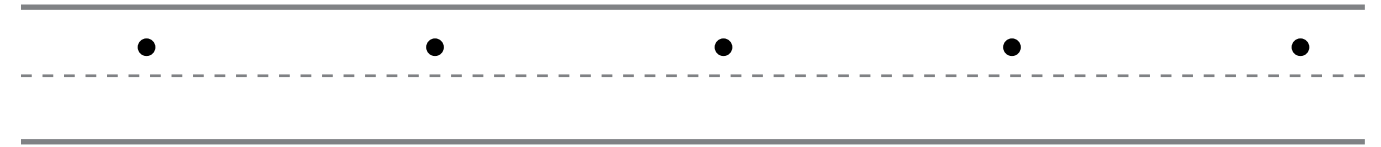
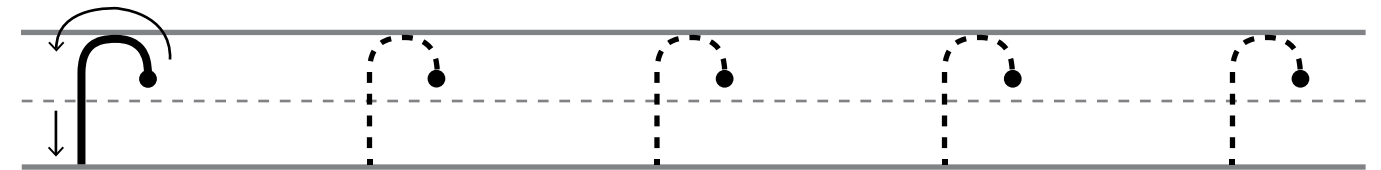
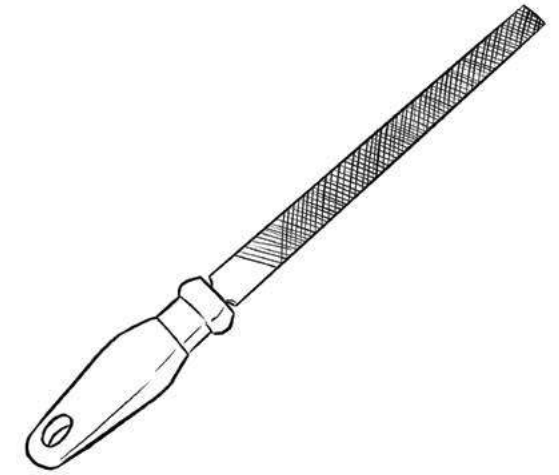
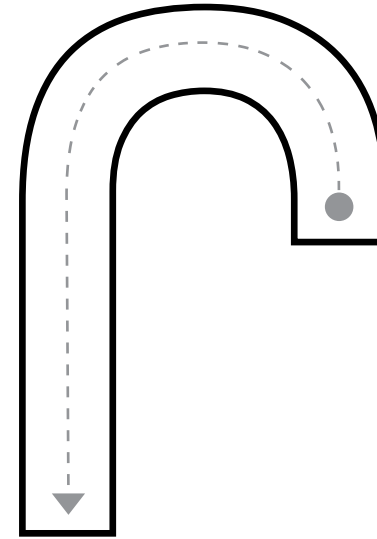
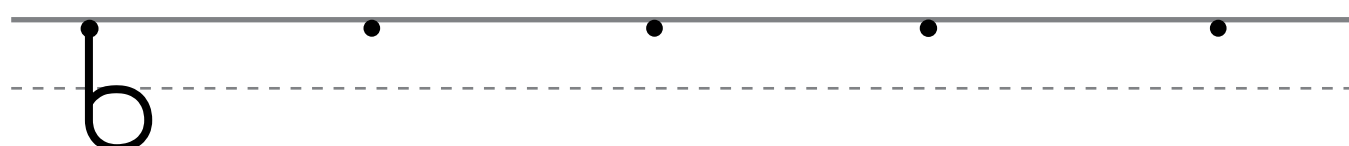
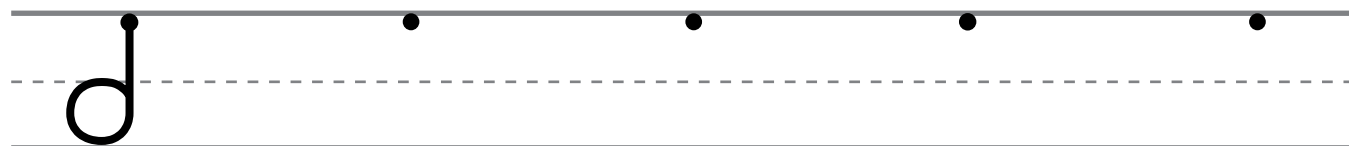
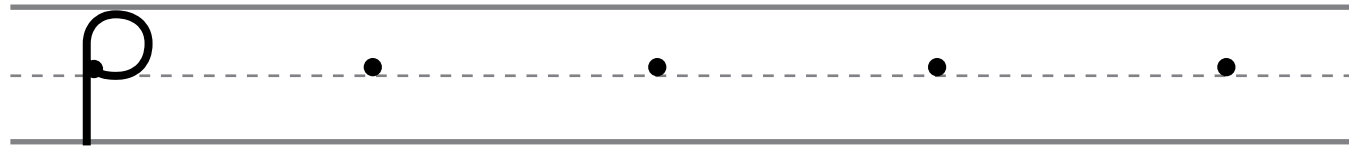
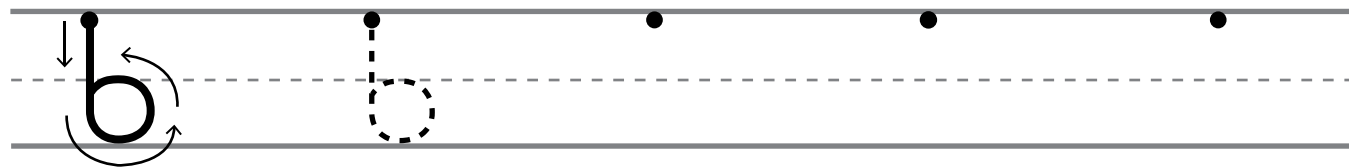
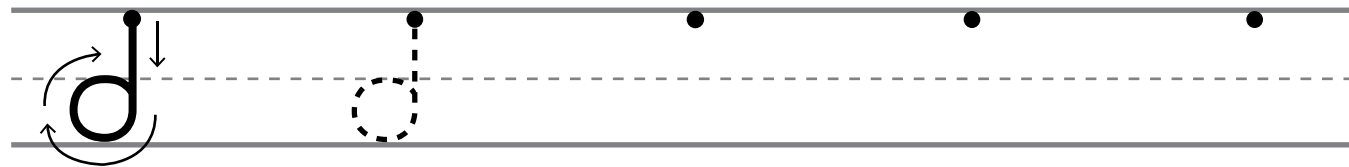
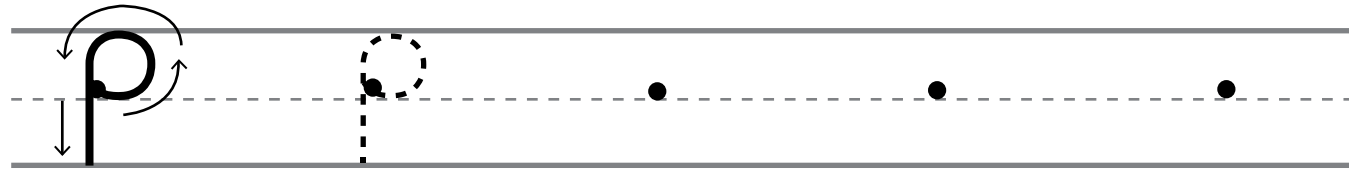
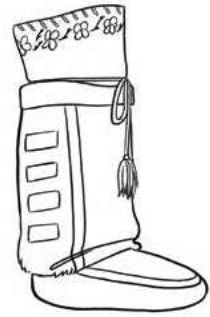
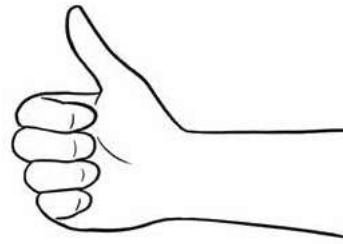
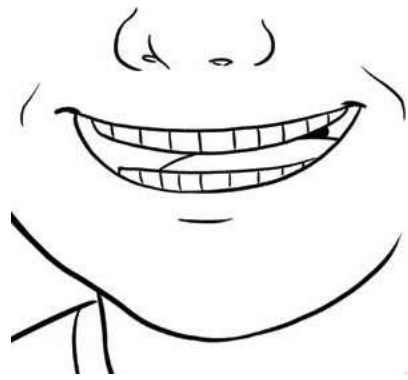

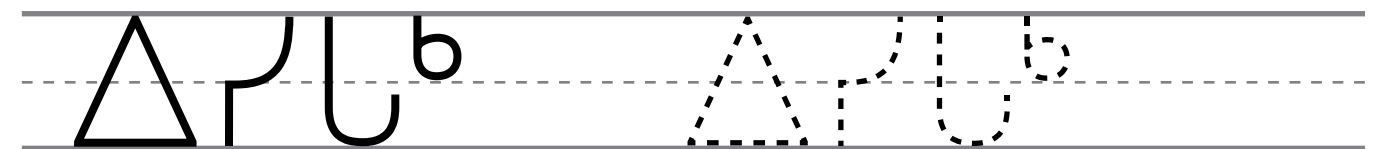
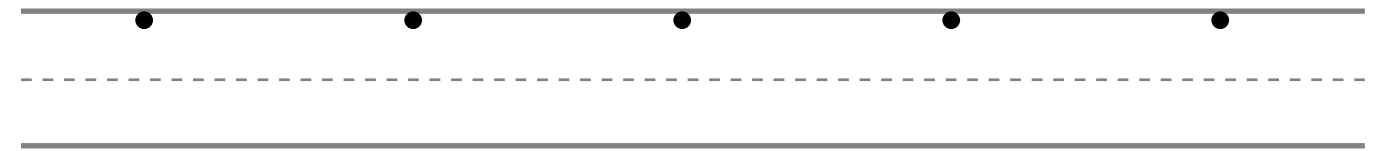
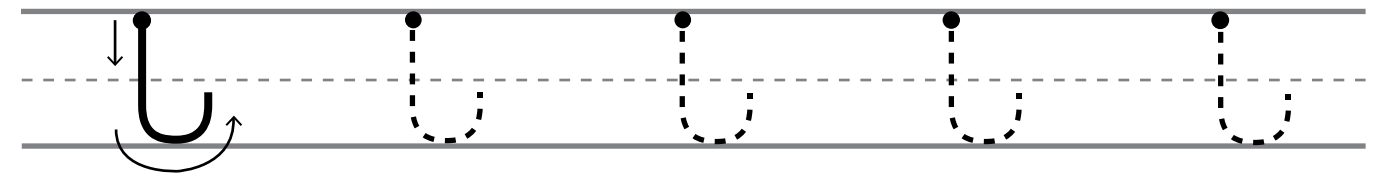
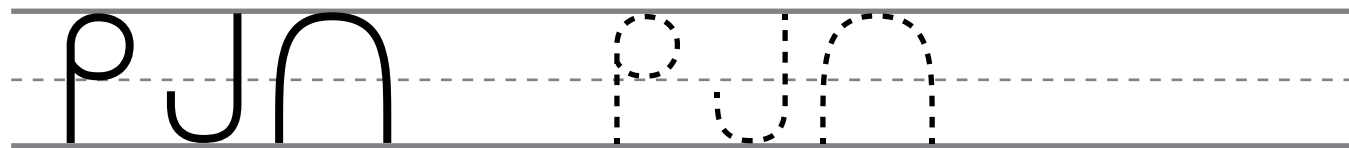
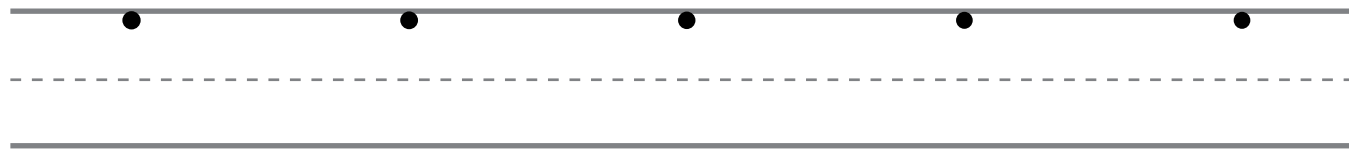
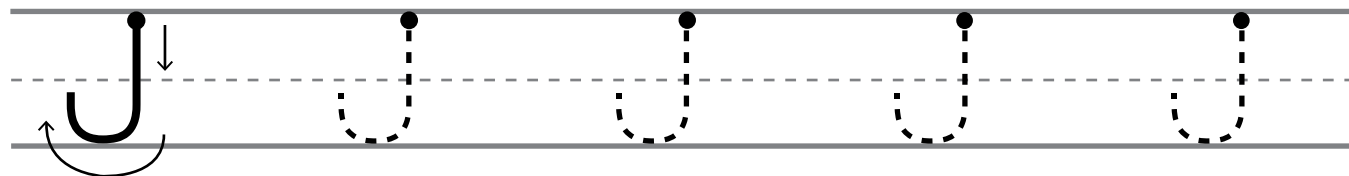
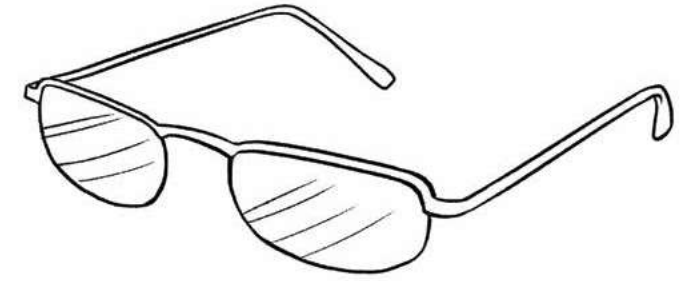
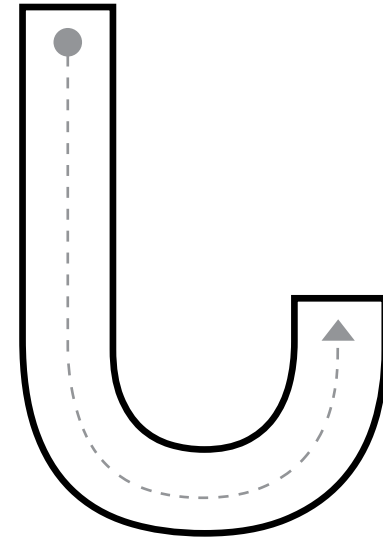
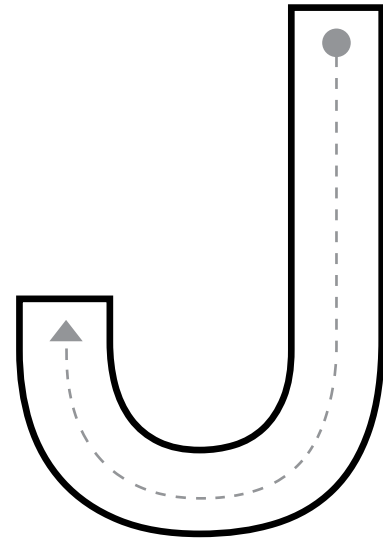
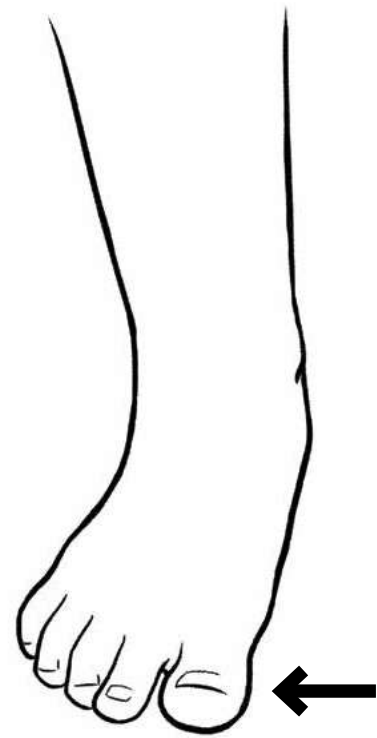

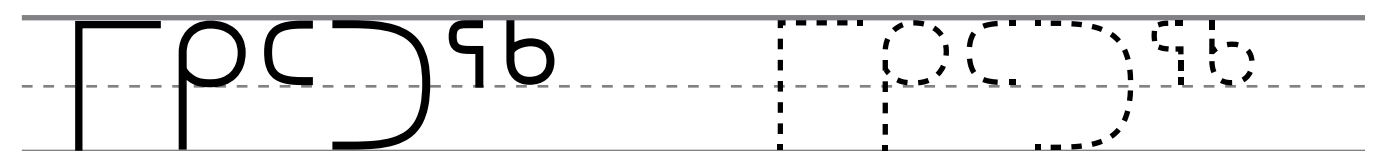
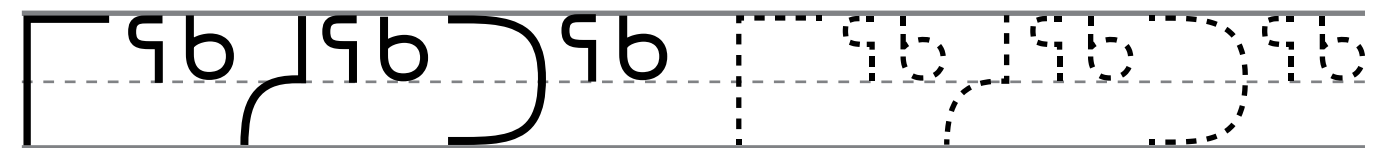
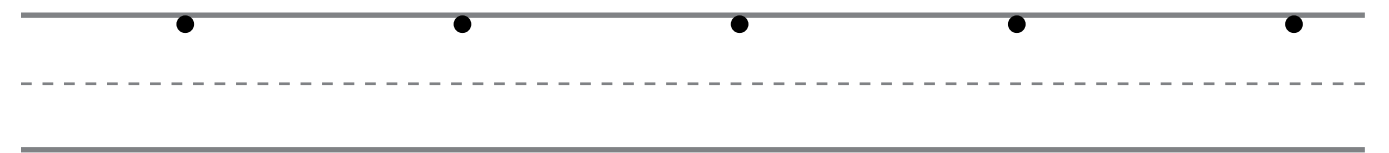
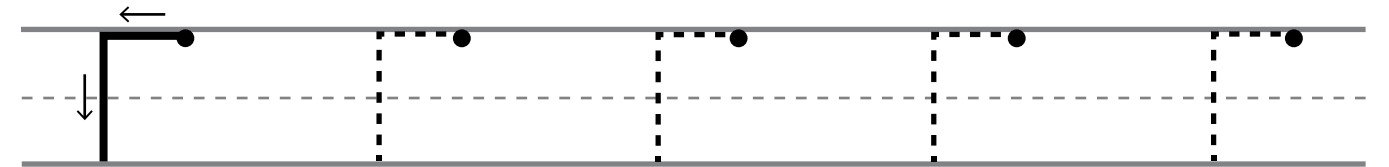
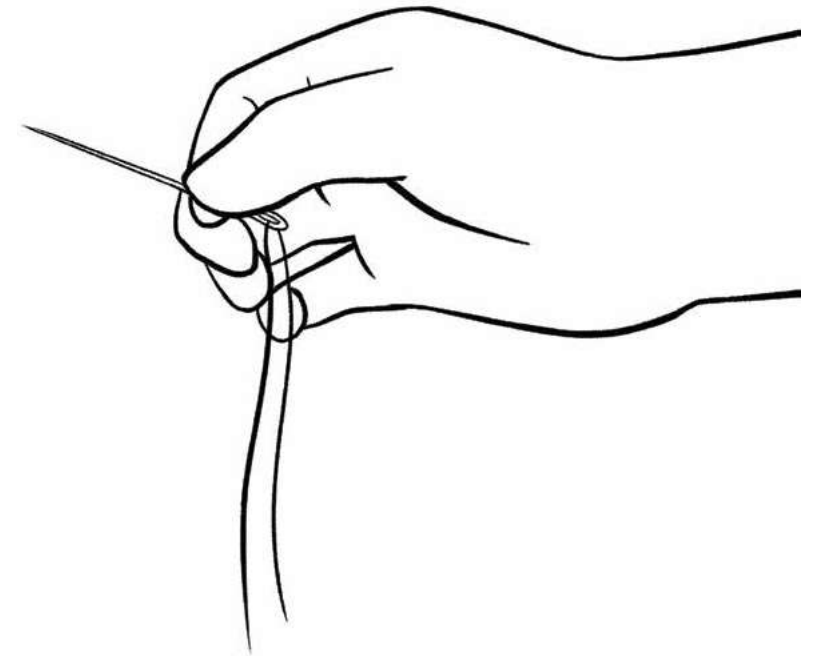
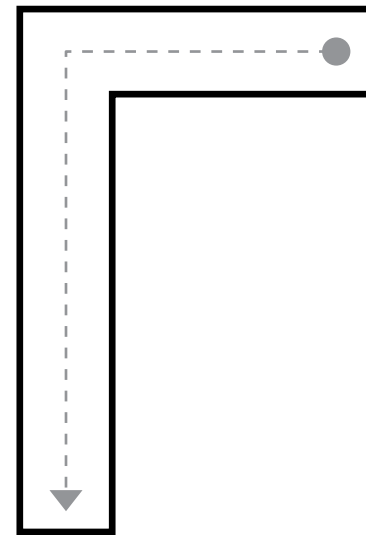
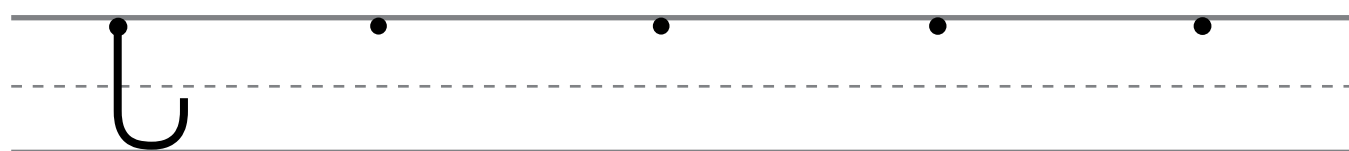
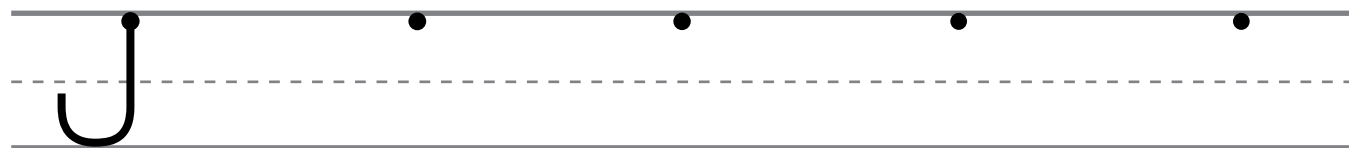
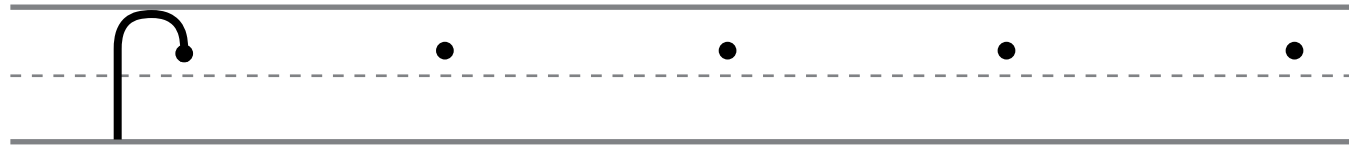
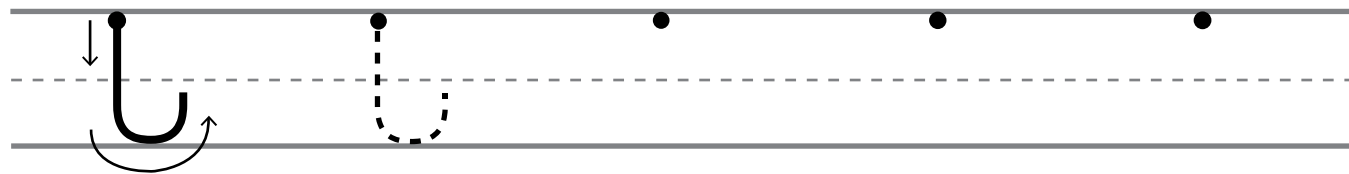
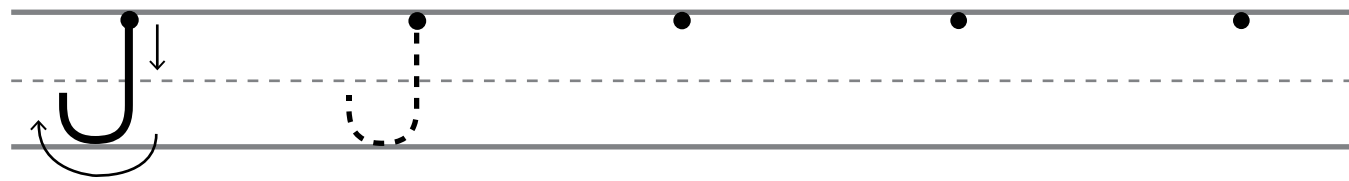
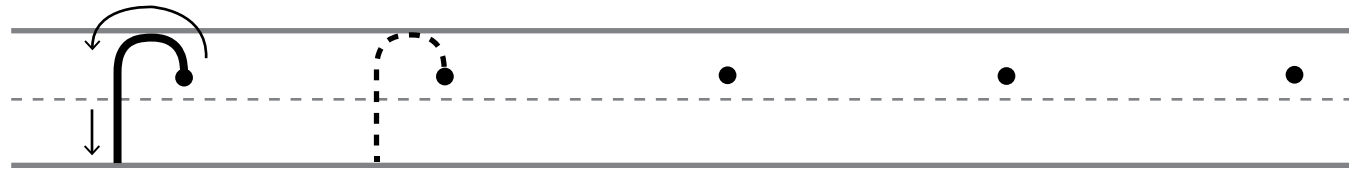
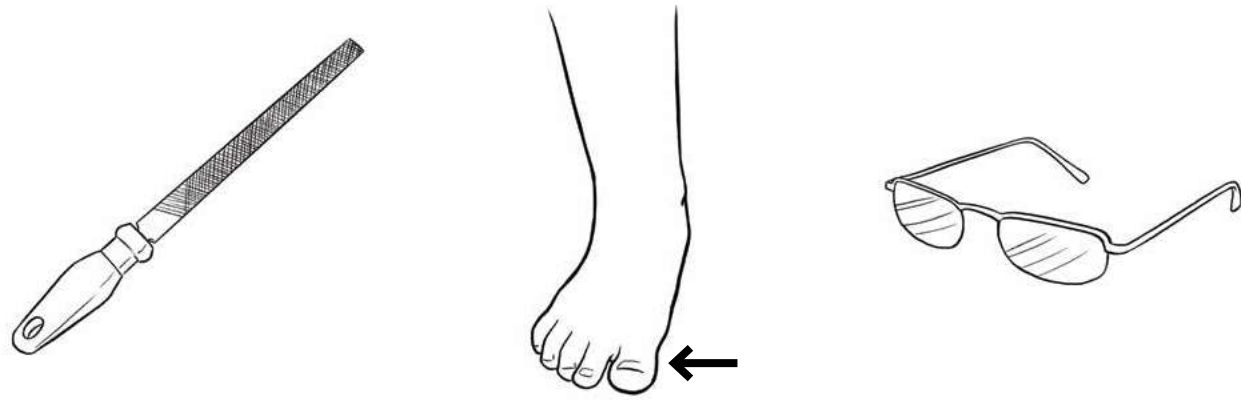

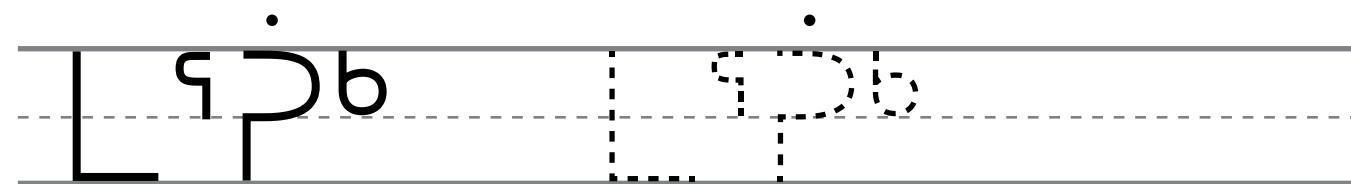
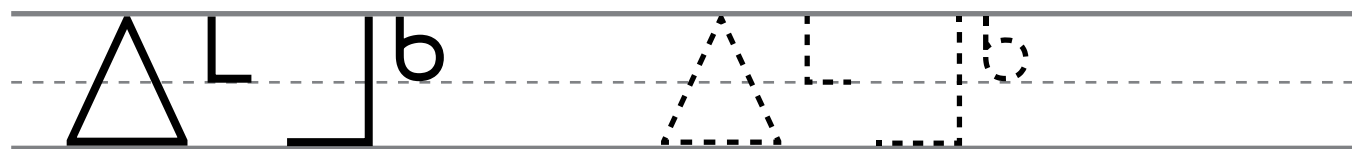
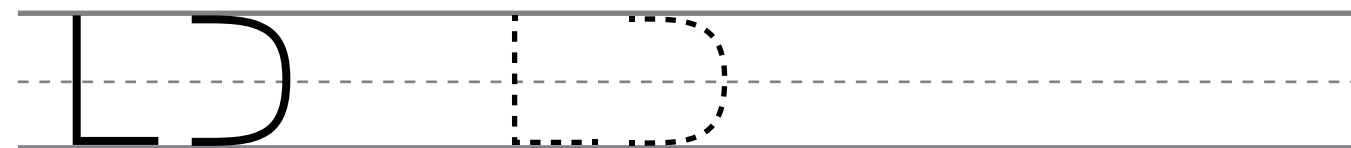
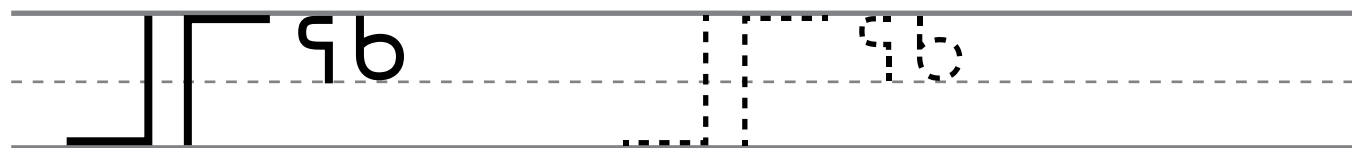
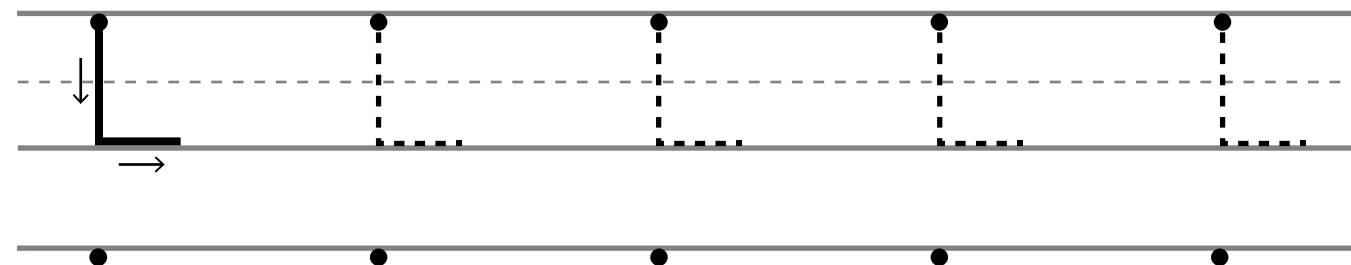
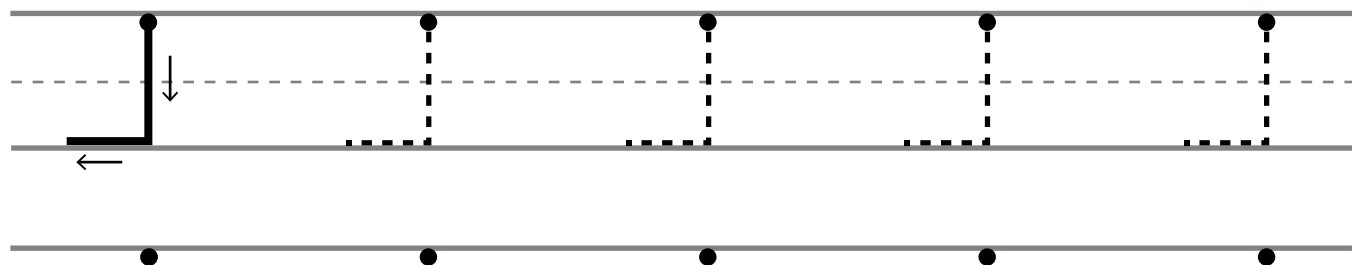
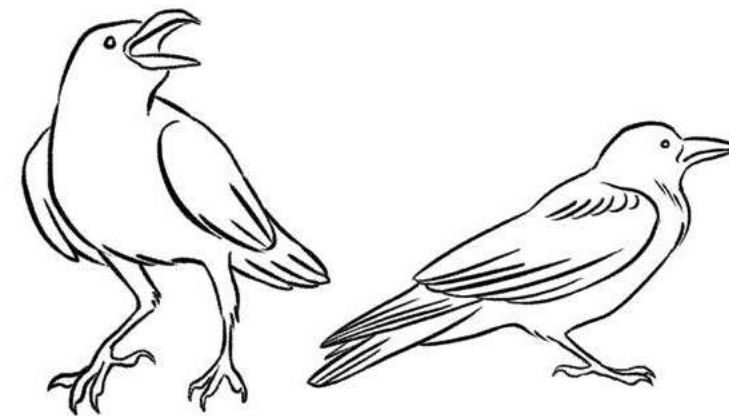
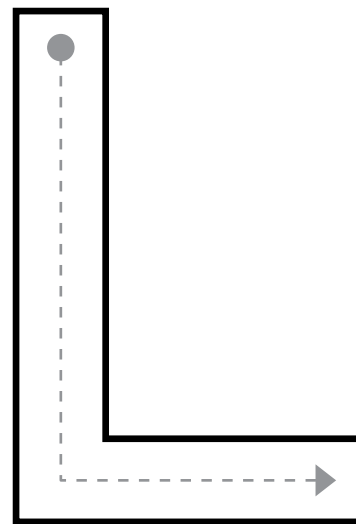
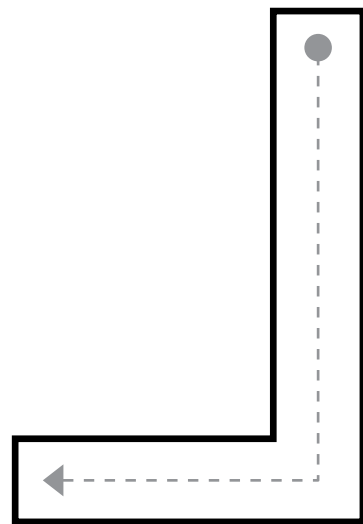



Handwriting practice for the letter 'L' on a four-line grid. The first row shows a solid 'L' with arrows indicating stroke direction (down, then left) and a dashed 'L' for tracing. The second row shows a solid 'L' with arrows and a dashed 'L' for tracing. The third row shows a solid 'L' with arrows and a dashed 'L' for tracing. The fourth row shows a solid 'L' and four dots on the top line. The fifth row shows a solid 'L' and four dots on the top line. The sixth row shows a solid 'L' and four dots on the top line. The seventh row shows a solid 'L' and four dots on the top line.

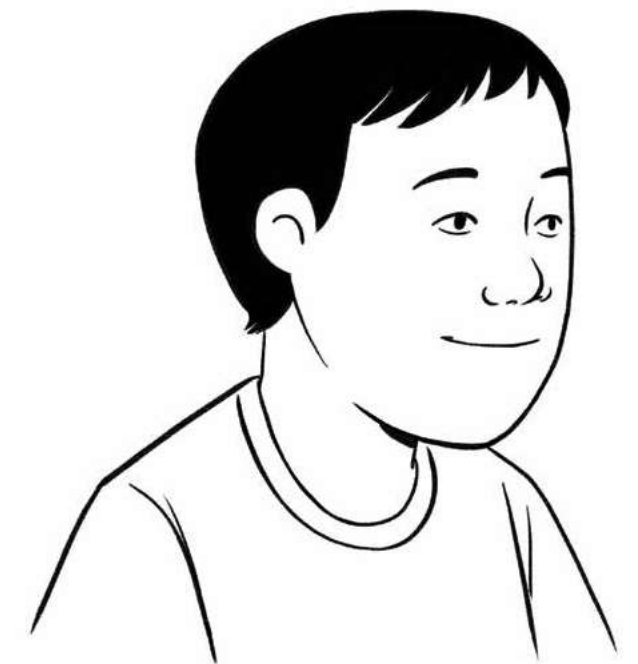
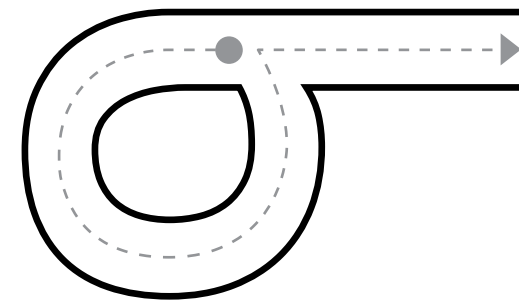

Handwriting practice for the letter 'Q' on a four-line grid. The first row shows a solid 'Q' with arrows indicating stroke direction (counter-clockwise circle, then right) and four dashed 'Q's for tracing. The second row shows five dots on the top line. The third row shows a solid 'Q' with arrows and a dashed 'Q' for tracing, followed by a dashed 'Q' with arrows and a dashed 'Q' for tracing. The fourth row shows a solid 'Q' with arrows, a triangle with arrows, and a dashed 'Q' with arrows, followed by a dashed 'Q' with arrows, a triangle with arrows, and a dashed 'Q' with arrows.

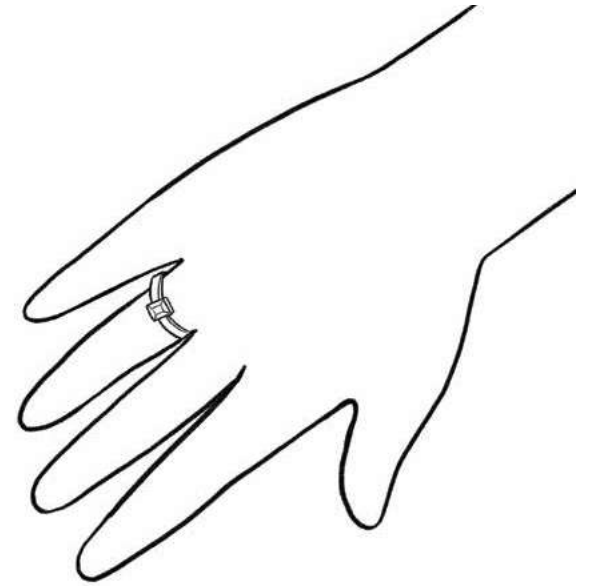
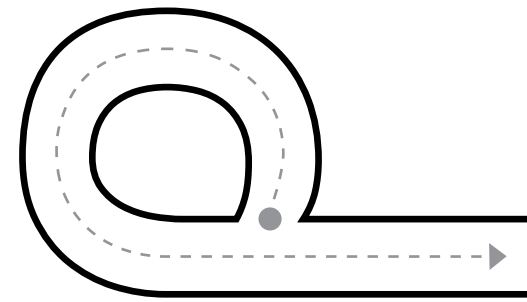
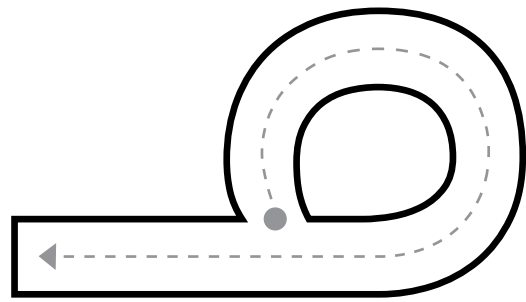

Tracing practice for lowercase letter 'o' on a three-line grid. The first row contains five 'o's: the first is solid with directional arrows, and the others are dashed. The second row contains five dots on the middle line. The third row contains two 'o's with dashed outlines and arrows indicating stroke direction. The fourth row contains two 'o's with dashed outlines and arrows indicating stroke direction.

Tracing practice for lowercase letter 'o' on a three-line grid. The first row contains five 'o's: the first is solid with directional arrows, and the others are dashed. The second row contains five dots on the middle line. The third row contains two 'o's with dashed outlines and arrows indicating stroke direction. The fourth row contains two 'o's with dashed outlines and arrows indicating stroke direction.



Handwriting practice for page 28. It consists of six rows of three-line guides (top, middle dashed, bottom).
Row 1: Letter 'o'. Shows stroke order (counter-clockwise circle) and a dotted line for tracing. Followed by four dots on the middle line for independent practice.
Row 2: Letter 'b'. Shows stroke order (vertical line down, then counter-clockwise circle) and a dotted line for tracing. Followed by four dots on the middle line for independent practice.
Row 3: Letter 'q'. Shows stroke order (counter-clockwise circle, then vertical line down, then a short horizontal tail) and a dotted line for tracing. Followed by four dots on the middle line for independent practice.
Row 4: Letter 'p'. Shows a solid letter followed by four dots on the middle line for independent practice.
Row 5: Letter 'B'. Shows a solid letter followed by four dots on the middle line for independent practice.
Row 6: Letter 'R'. Shows a solid letter followed by four dots on the middle line for independent practice.

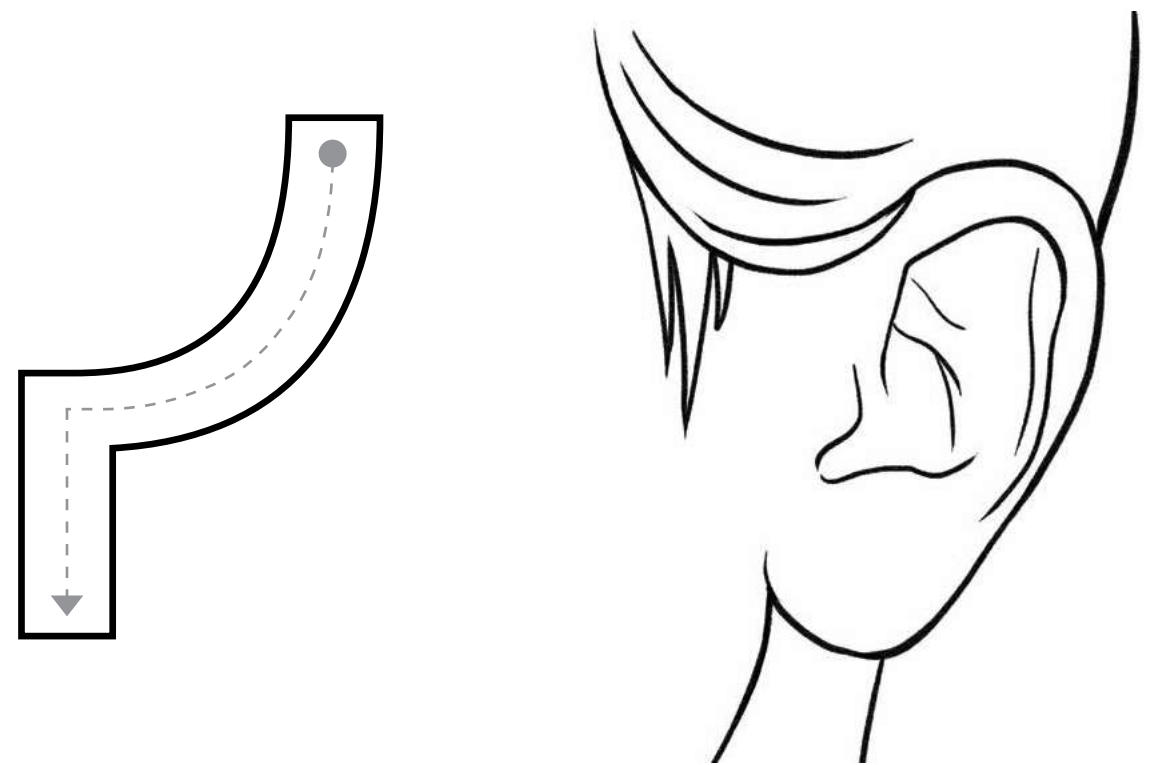

Handwriting practice for page 29. It consists of four rows of three-line guides (top, middle dashed, bottom).
Row 1: Letter 'P'. Shows stroke order (vertical down, then curve) and a dotted line for tracing. Followed by four dots on the middle line for independent practice.
Row 2: Letter 'b'. Shows a solid letter followed by four dots on the middle line for independent practice.
Row 3: Letter 'B'. Shows a solid letter followed by four dots on the middle line for independent practice.
Row 4: Letter 'R'. Shows a solid letter followed by four dots on the middle line for independent practice.

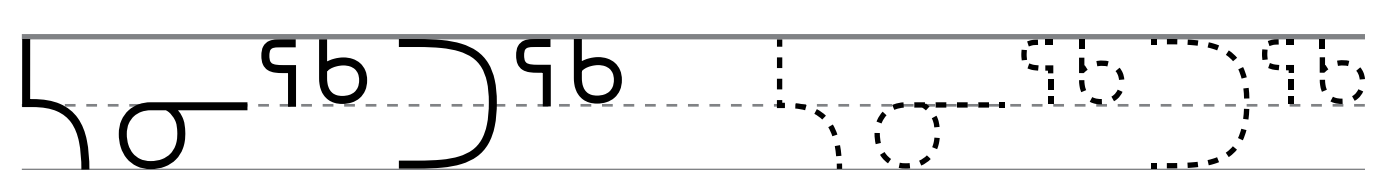
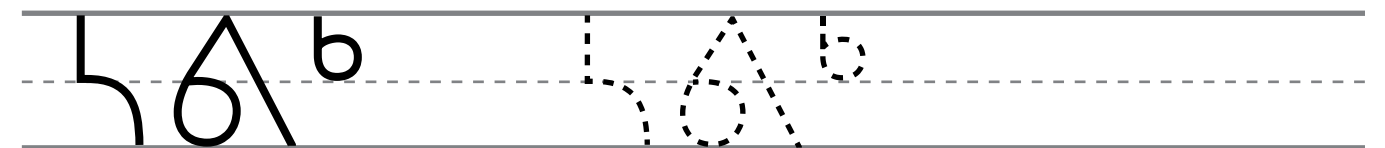
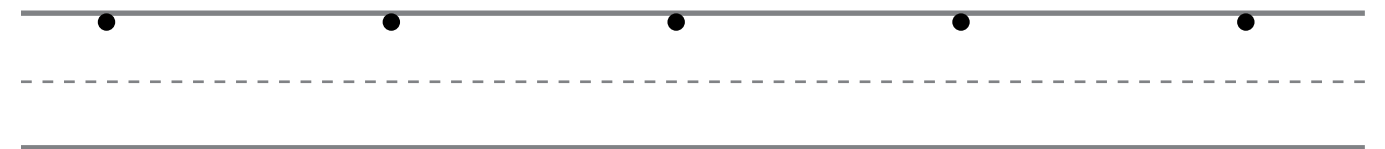
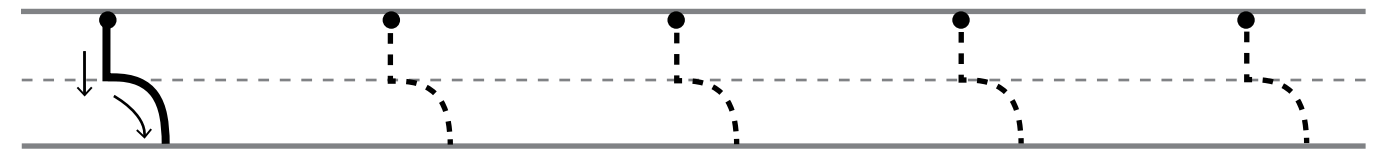
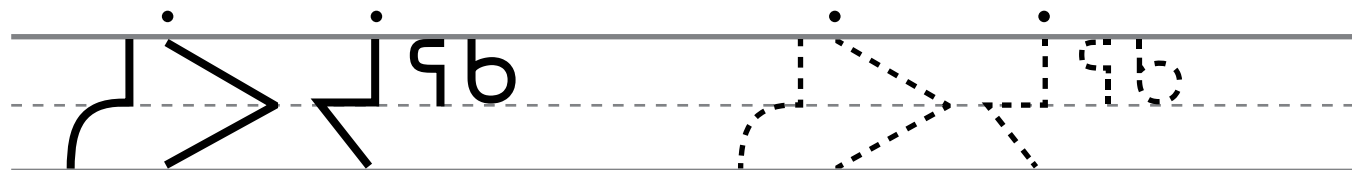
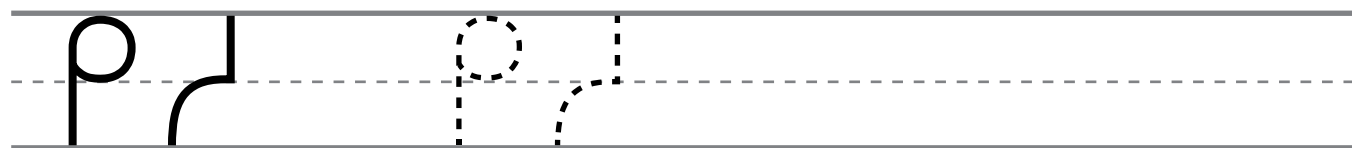
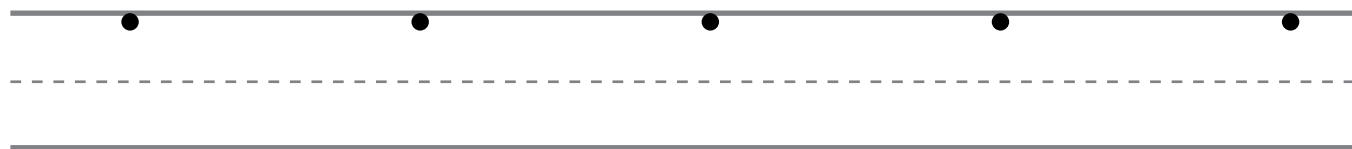
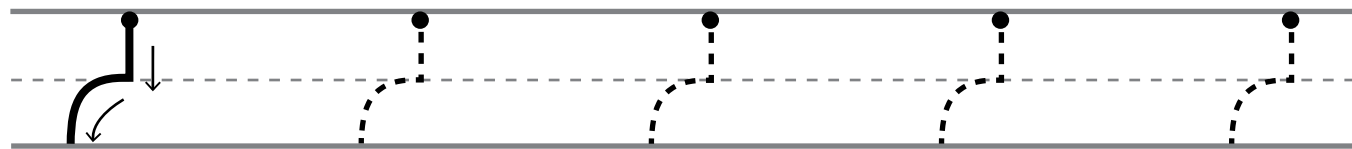
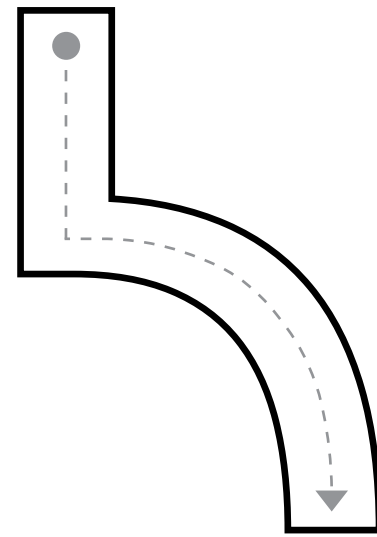
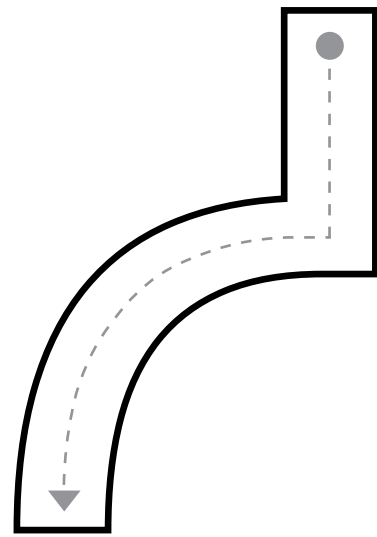
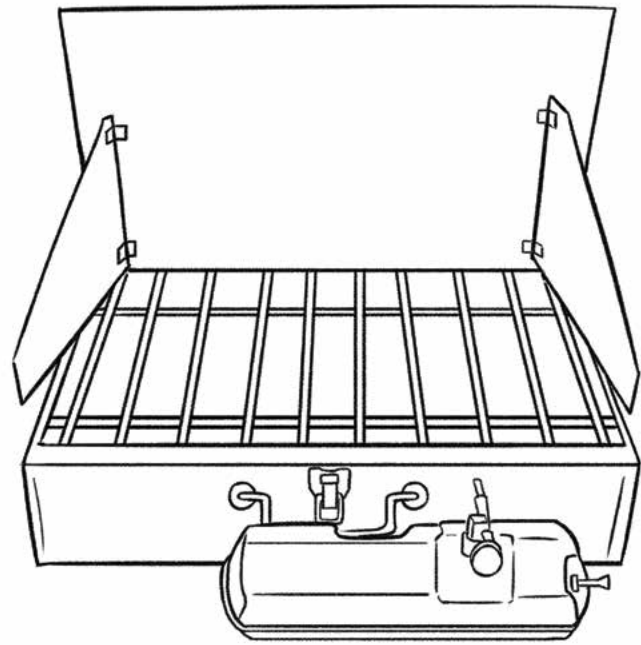

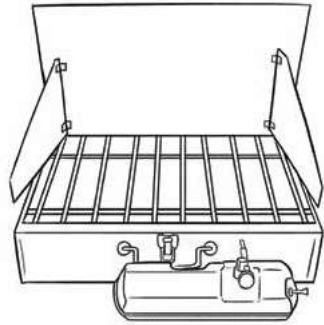
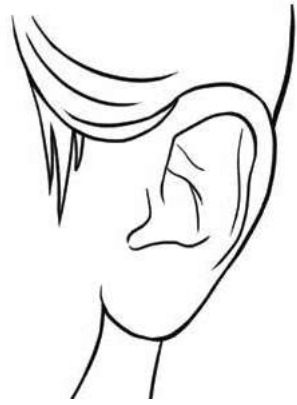

Handwriting practice lines for the letter 'C'. The page contains seven rows of three-line guides (top, middle dashed, bottom). Each row starts with a solid 'C' showing stroke direction (down, then curve right), followed by a dashed 'C' for tracing, and then five dots on the top line for independent practice.

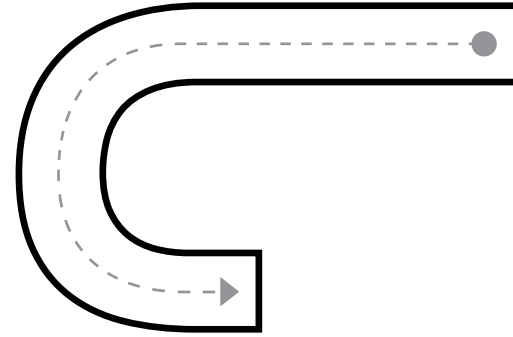

Handwriting practice lines for the letter 'C'. The page contains three rows of three-line guides. The first row shows a solid 'C' with stroke direction, followed by four dashed 'C's for tracing. The second row contains five dots on the top line for independent practice. The third row shows a solid 'C' with stroke direction, followed by a dashed 'C' for tracing, and then a solid 'C' with a triangle and the number '96' to its right, followed by a dashed version of the same for tracing.

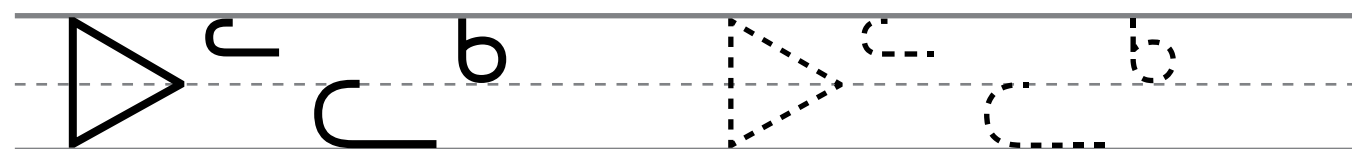
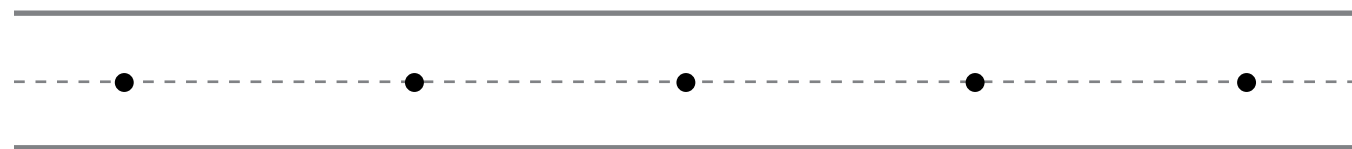
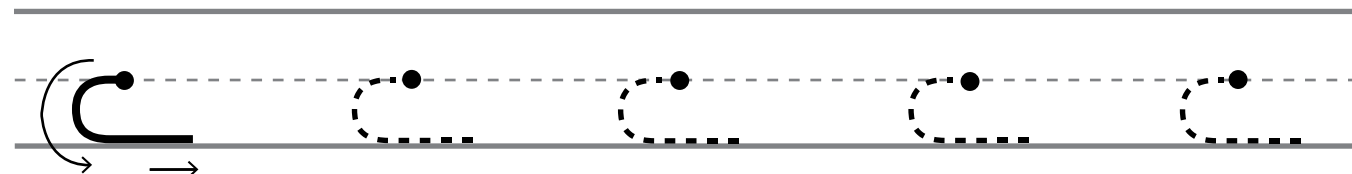
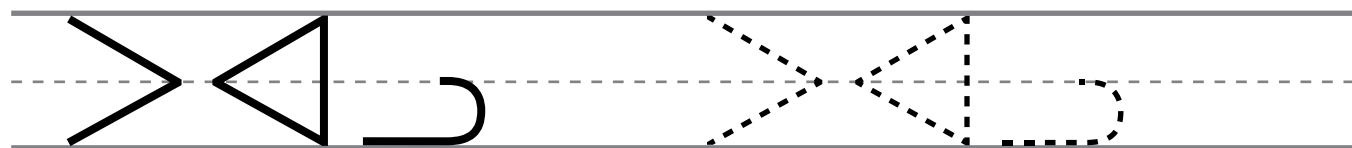
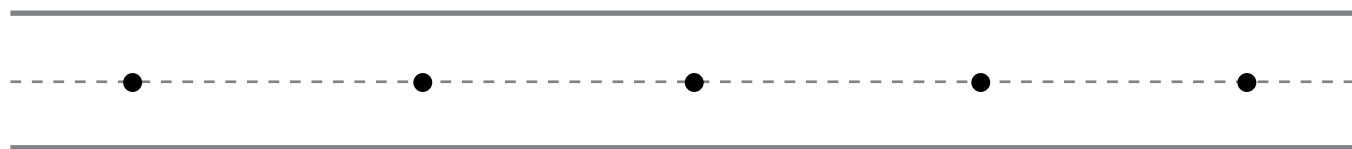
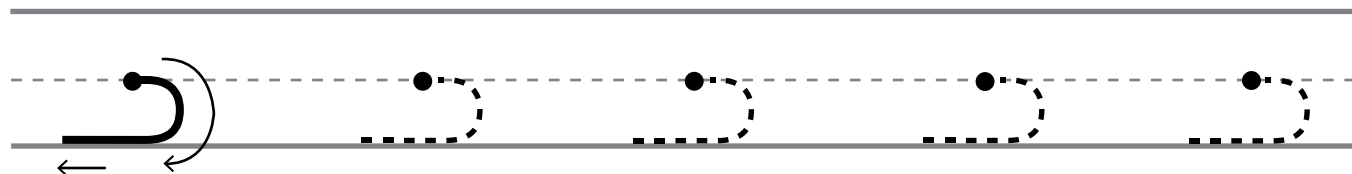
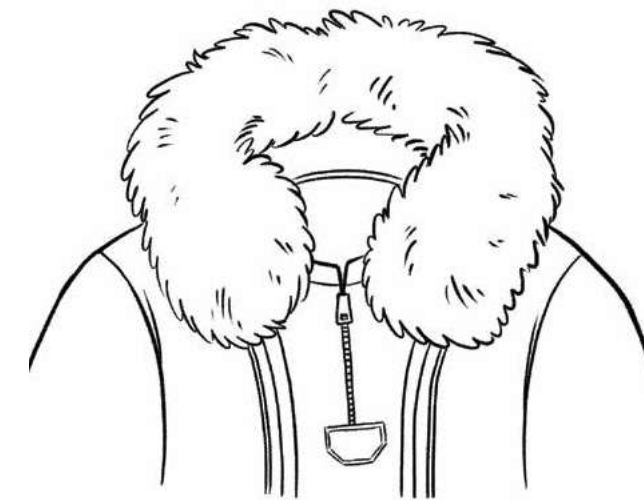
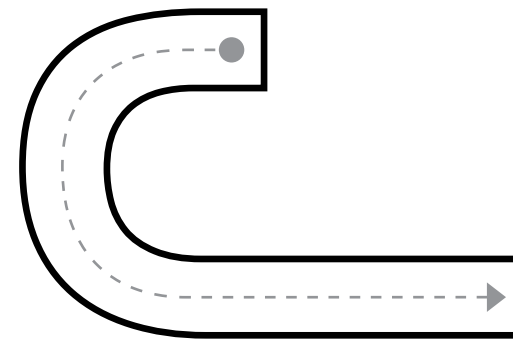
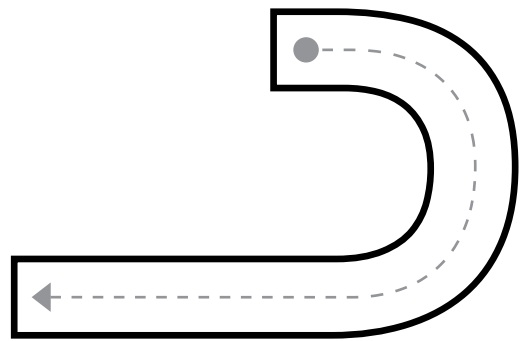
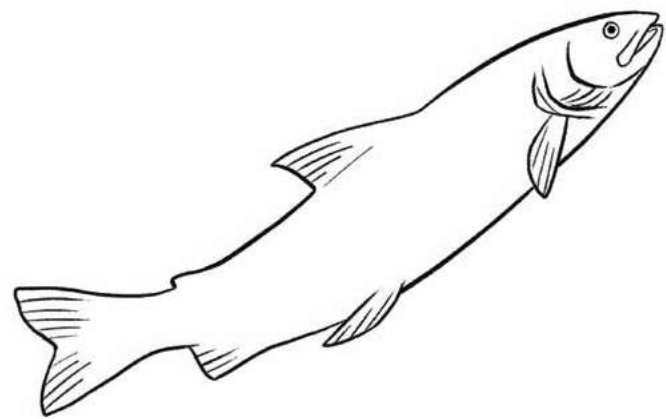

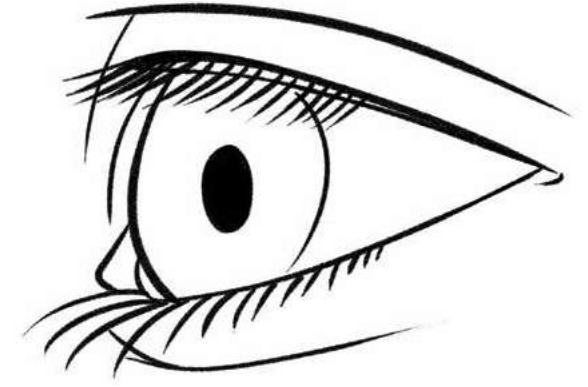
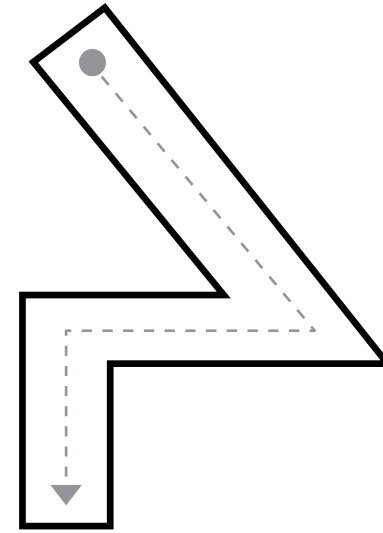
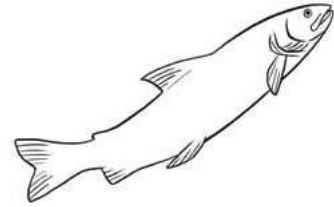

Handwriting practice for the letter 'U' on a three-line grid. The first row shows a solid 'U' with stroke direction arrows and a dashed 'U' for tracing. The second row shows a solid 'U' with stroke direction arrows and a dashed 'U' for tracing. The third row shows a solid 'U' with stroke direction arrows and a dashed 'U' for tracing. The fourth row shows a solid 'U' followed by four dots on the dashed line. The fifth row shows a solid 'U' followed by four dots on the dashed line. The sixth row shows a solid 'U' followed by four dots on the dashed line.

Handwriting practice for the letter 'A' on a three-line grid. The first row shows a solid 'A' with stroke direction arrows and four dashed 'A's for tracing. The second row shows five dots on the dashed line. The third row shows a solid 'A' with stroke direction arrows and a dashed 'A' for tracing. The fourth row shows a solid 'A' with stroke direction arrows and a dashed 'A' for tracing.

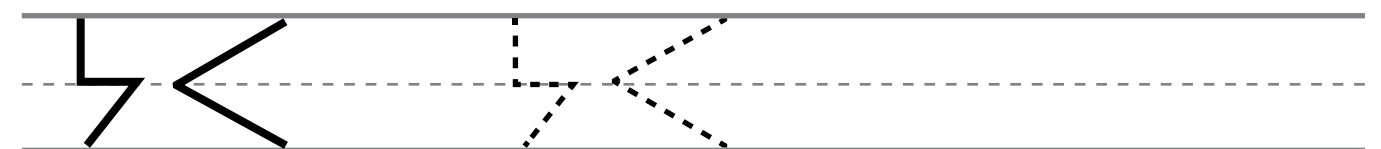
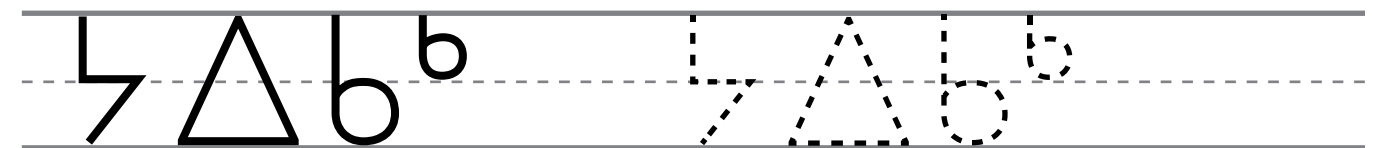
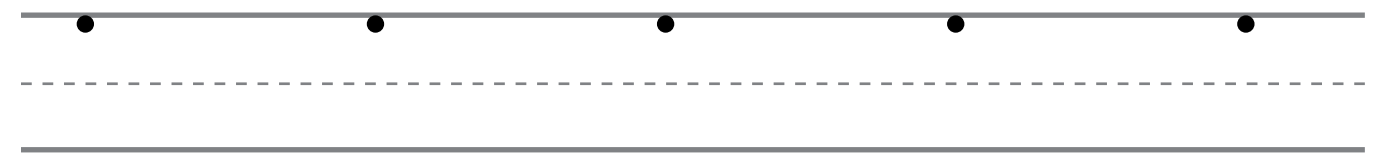
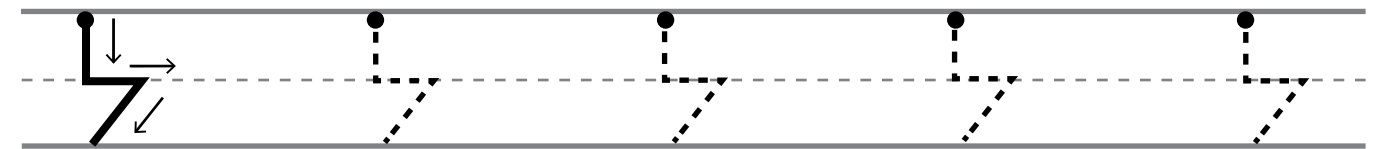
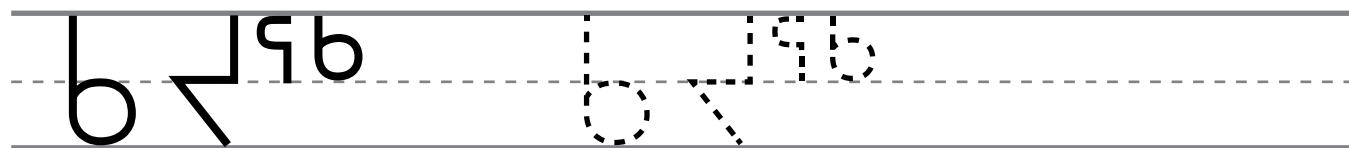
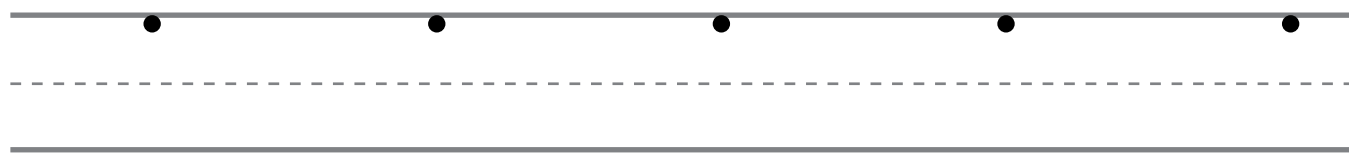
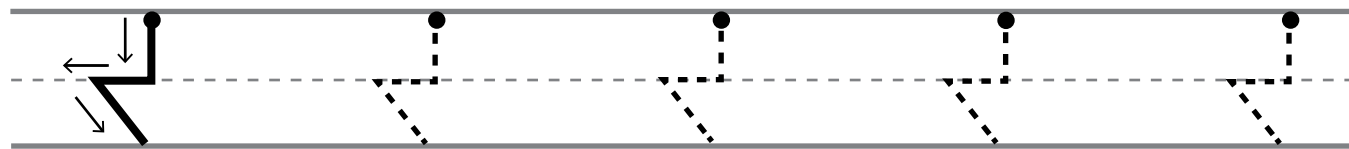
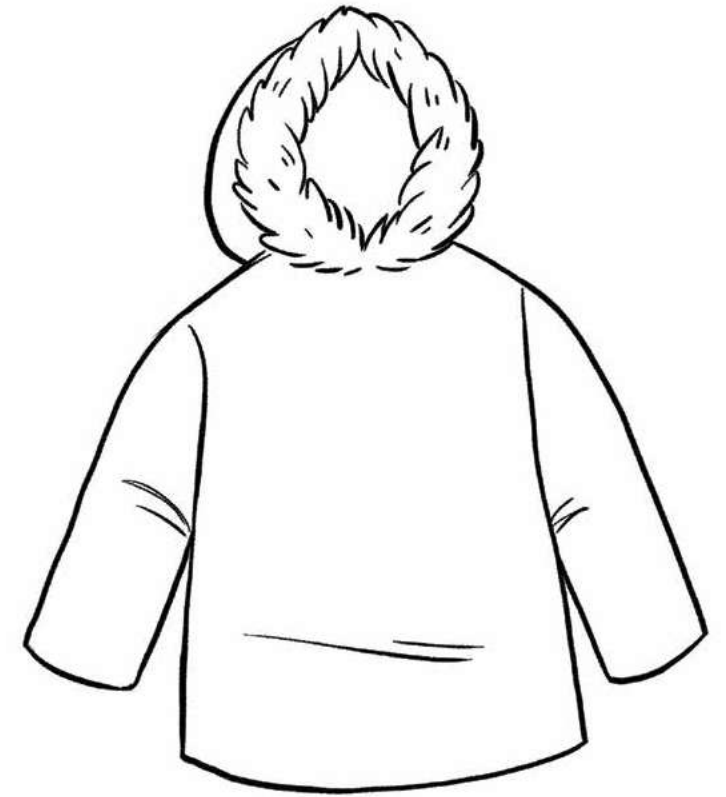
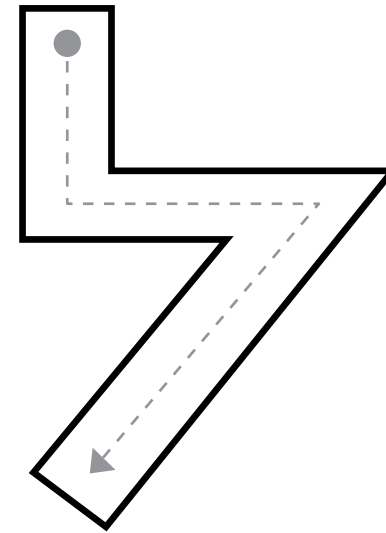
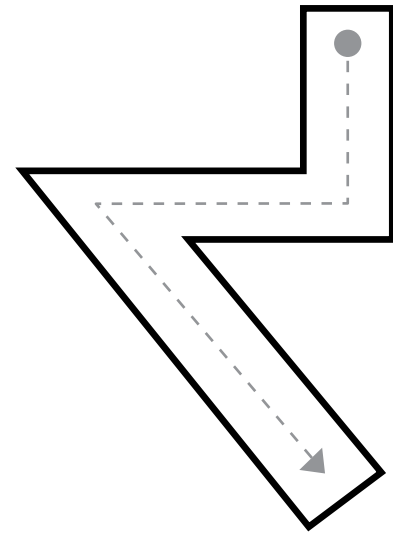
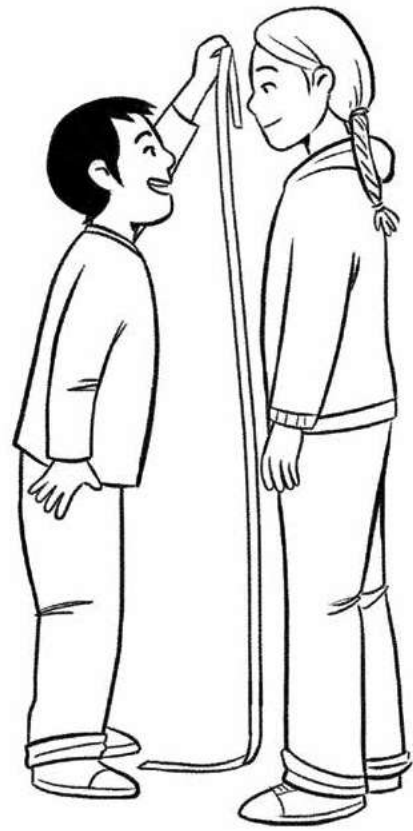

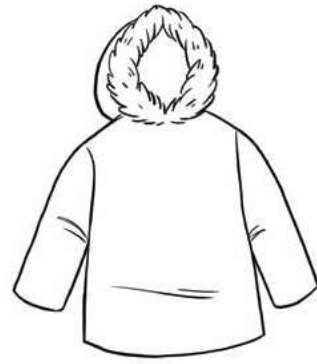
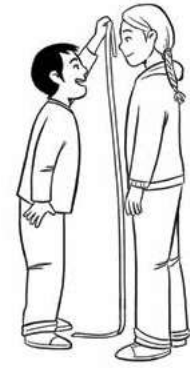
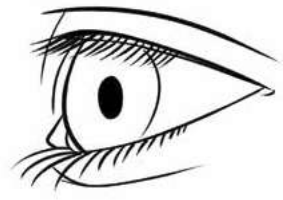

Handwriting practice lines for the Inuktitut syllable 'a' (ᐅ). The page contains six rows of three-line guides (top, middle dashed, bottom). Each row starts with a solid 'a' showing stroke order: a vertical line down, a horizontal line to the right, and a diagonal line down to the right. This is followed by a dashed 'a' for tracing, and then four dots for independent practice.

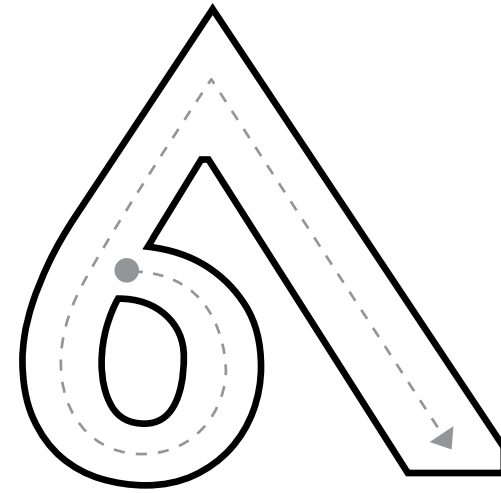

Handwriting practice lines for the Inuktitut syllable 'a' (ᐅ) and the letter 'b' (ᐁ). The page contains three rows of three-line guides. The first row shows a solid 'a' with stroke order arrows, followed by four dashed 'a's for tracing. The second row shows a solid 'b' with stroke order arrows, followed by four dashed 'b's for tracing. The third row shows a solid 'a' followed by a solid 'b', then four dashed 'a' and 'b' pairs for tracing.

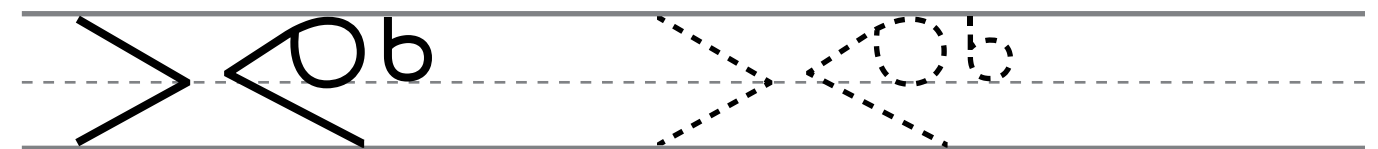
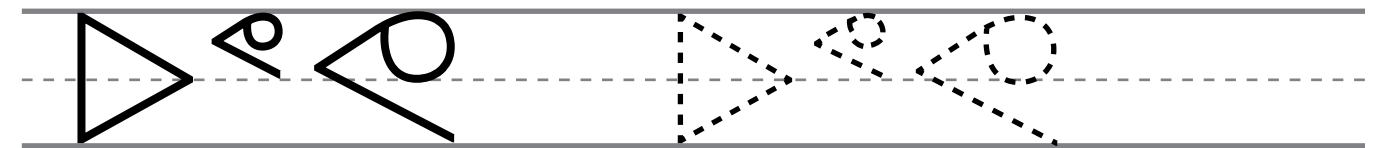
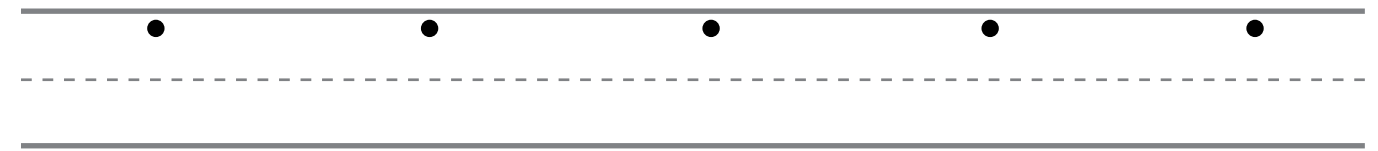
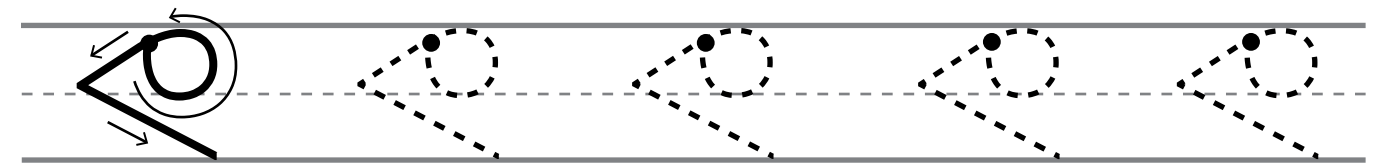
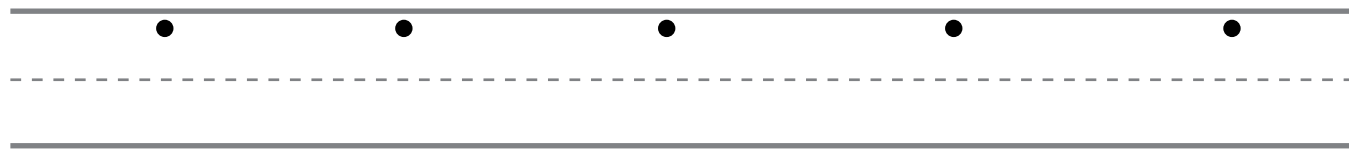
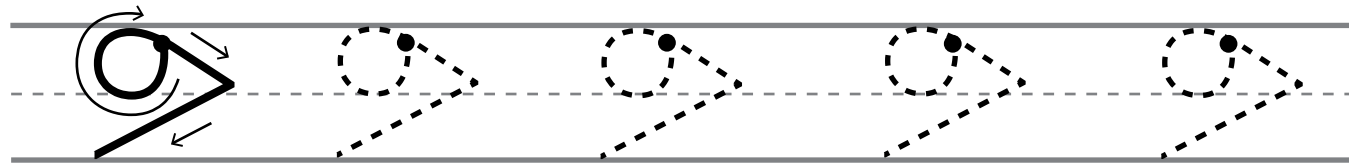
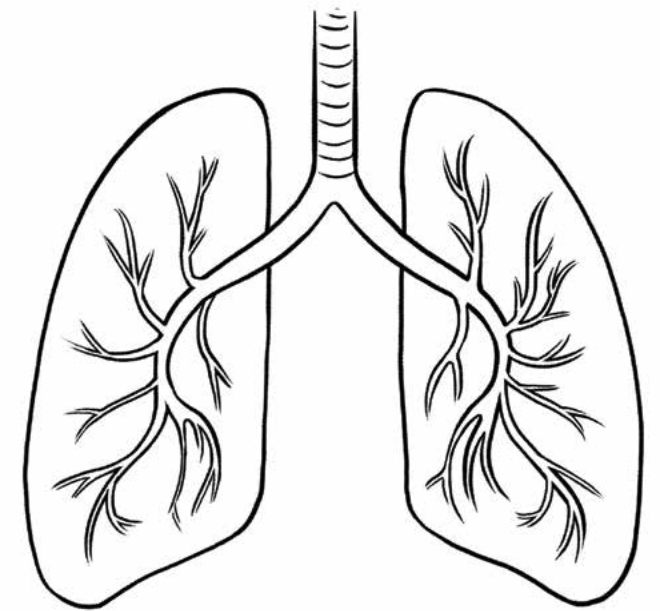
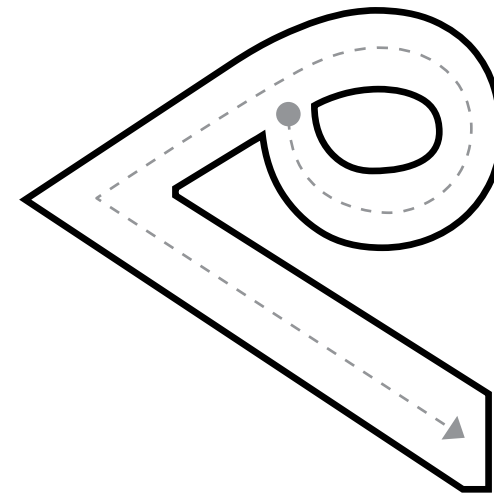
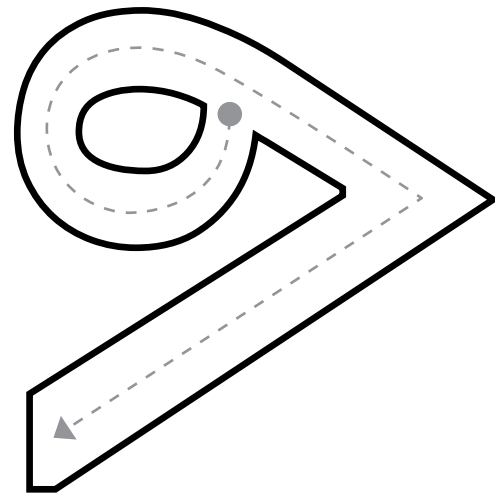
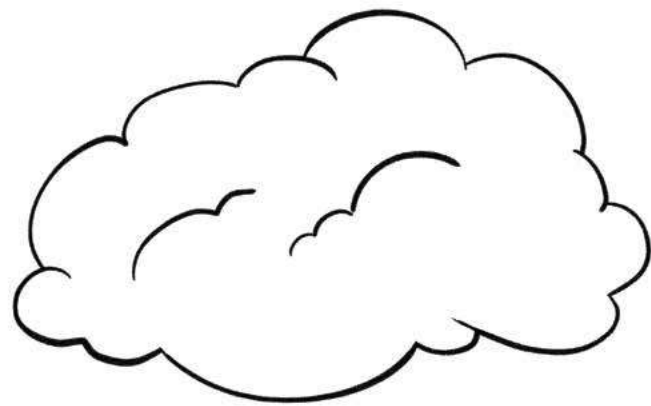

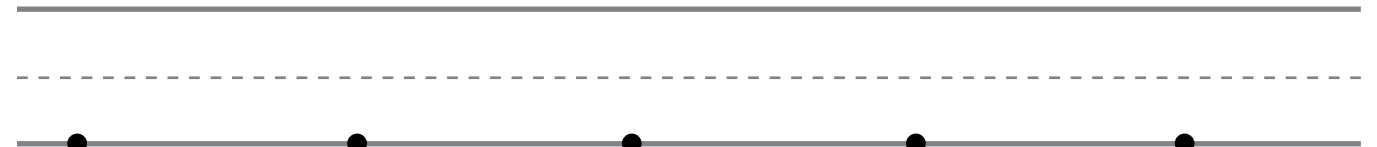
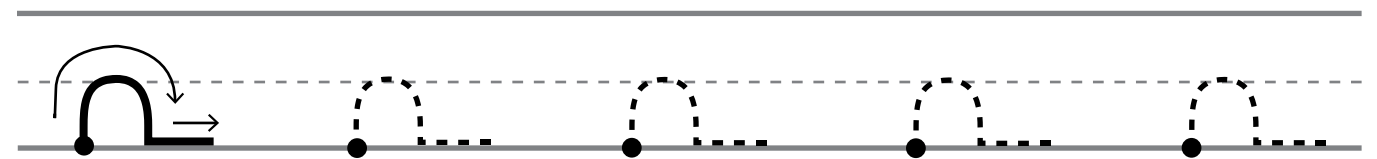
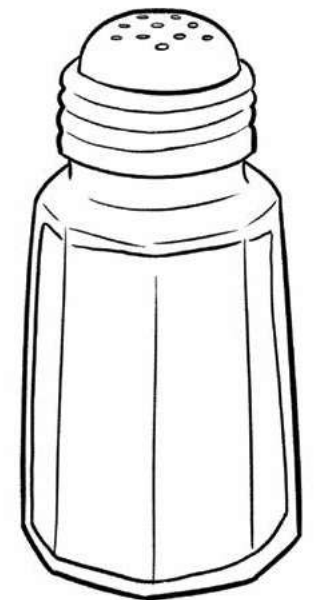
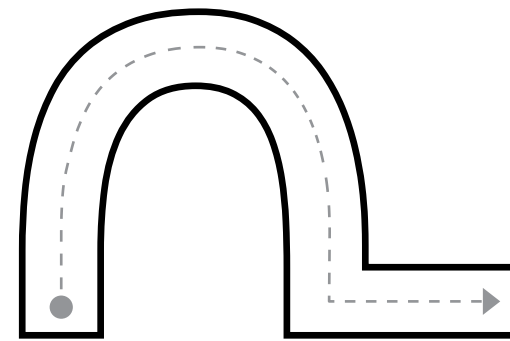
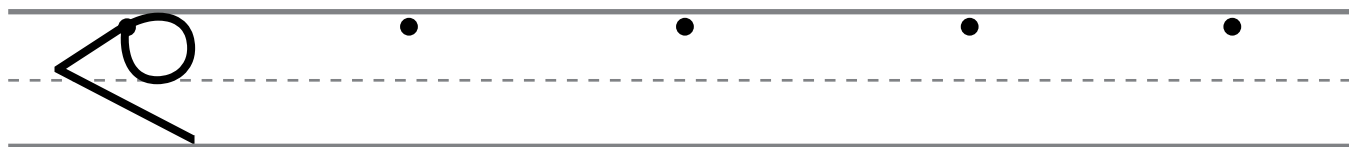
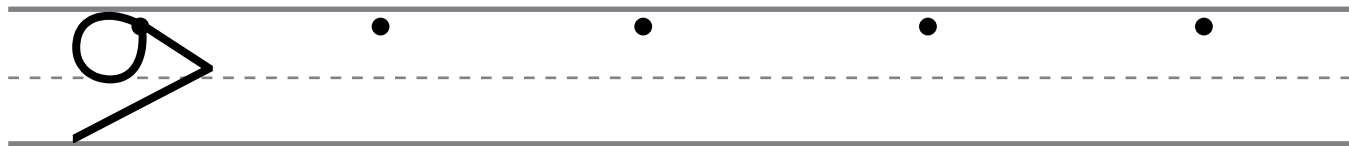
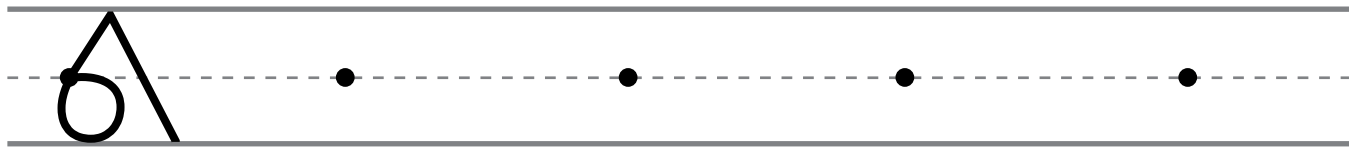
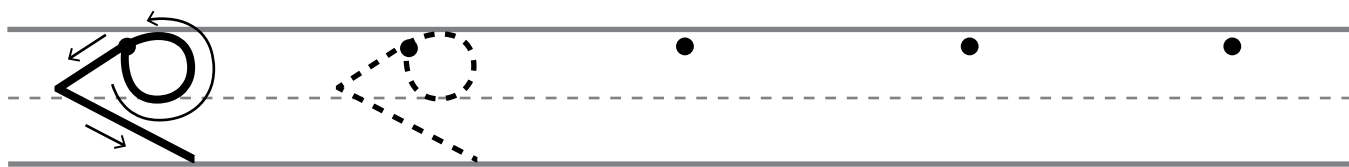
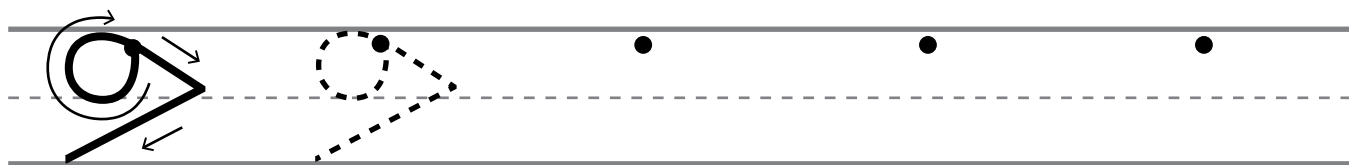
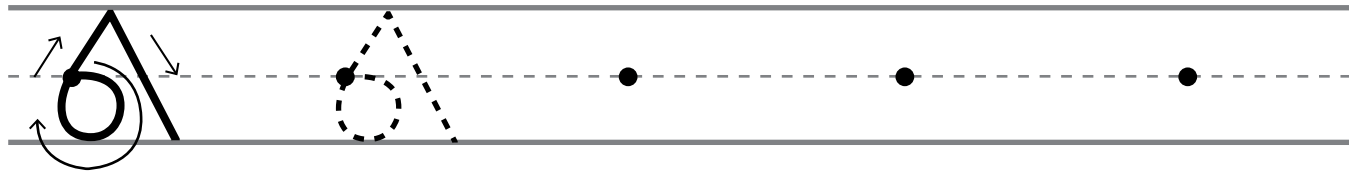
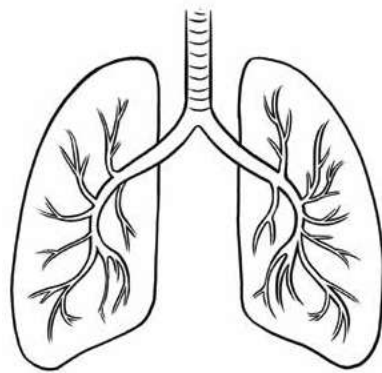
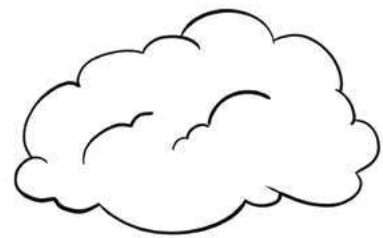

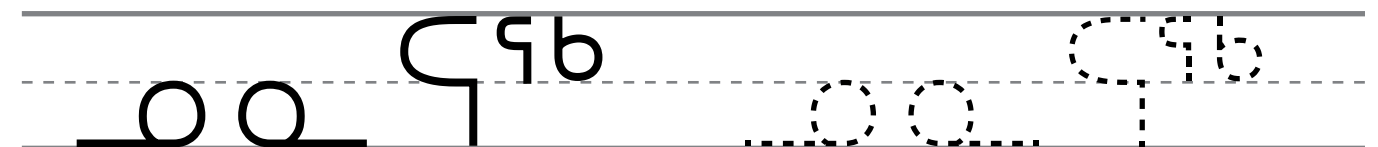
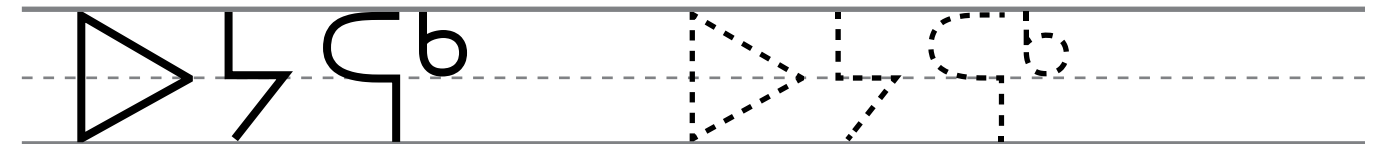
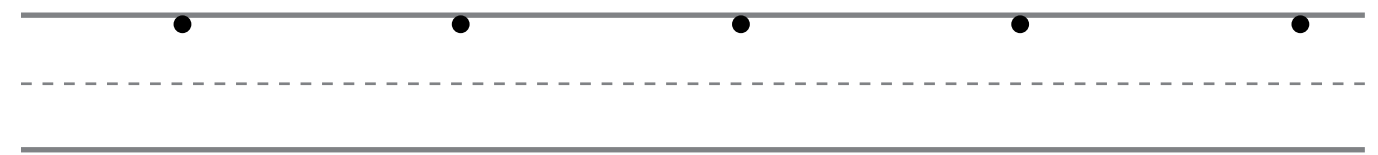
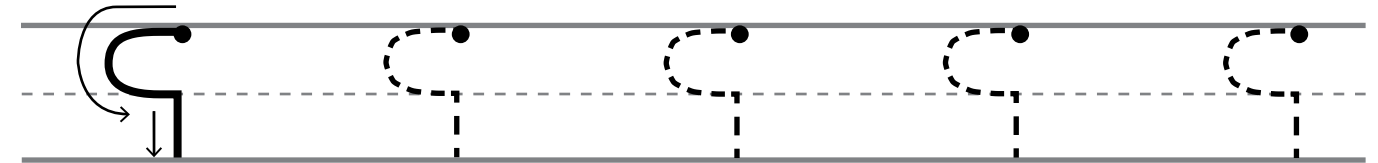
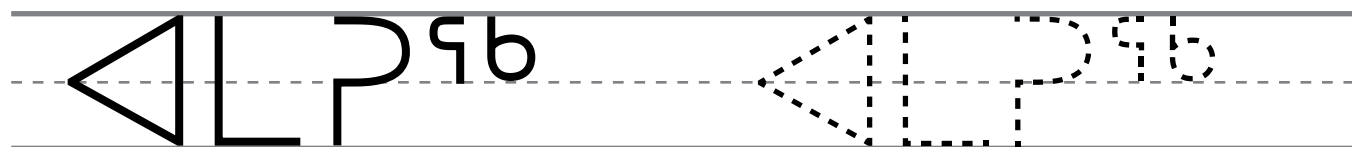
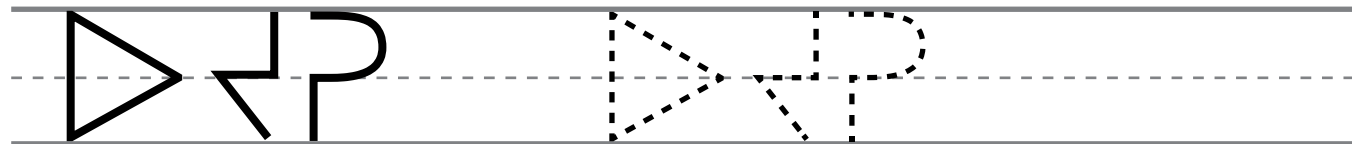
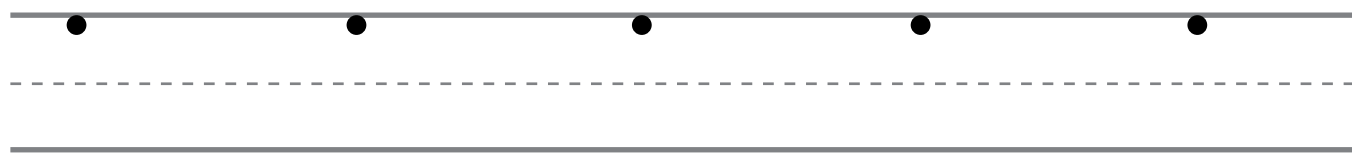
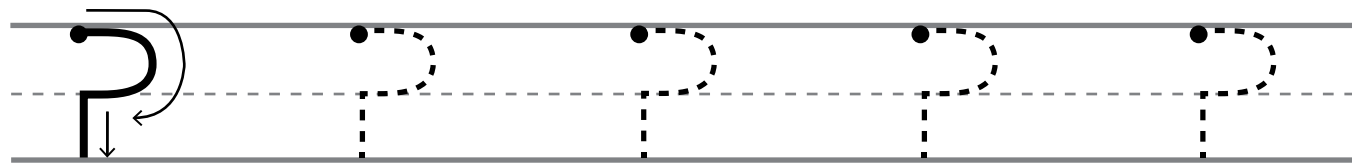
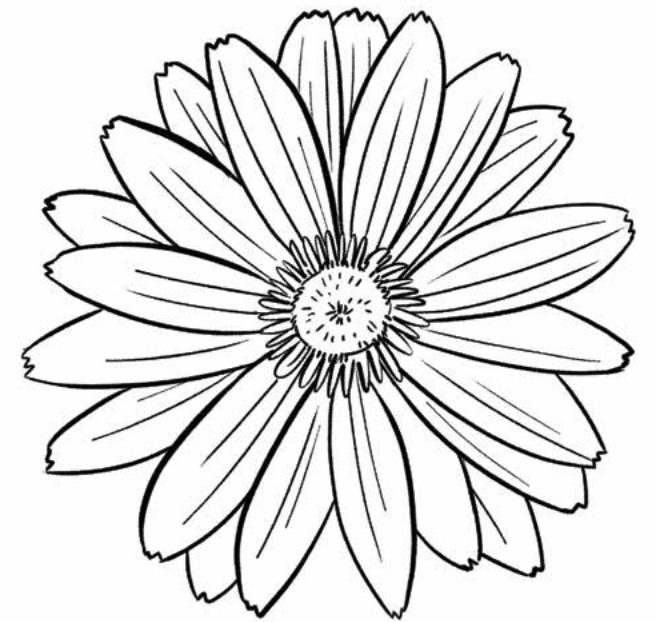
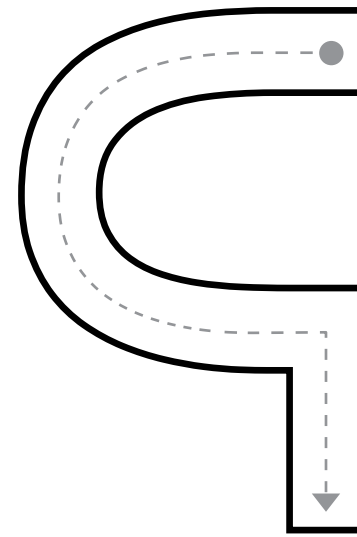
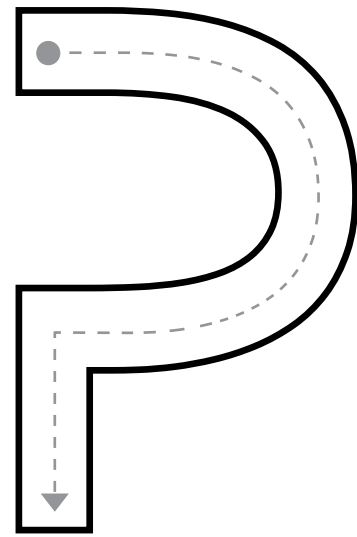
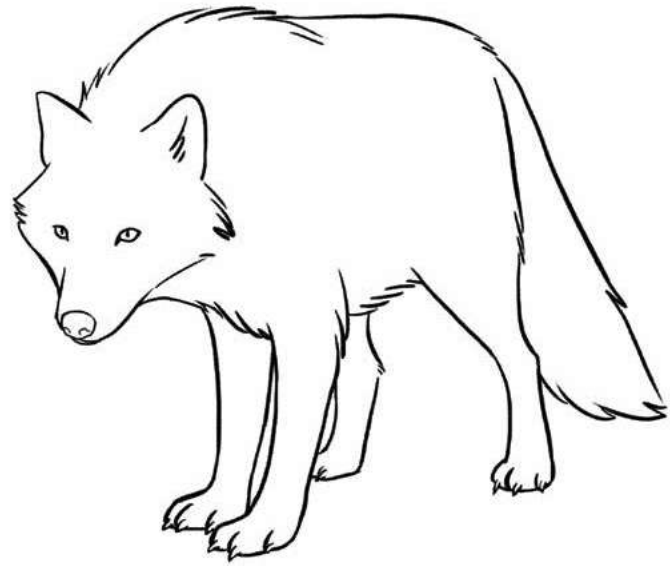

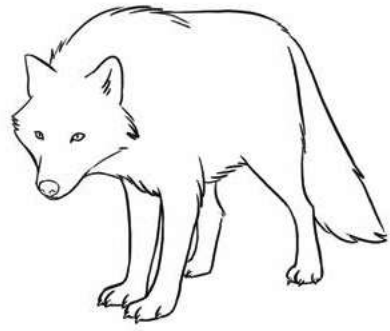

Handwriting practice lines for lowercase letters 'a', 'p', and 'q'. Each row shows a solid letter with stroke order arrows, followed by a dashed letter for tracing, and then five dots on a baseline for independent practice.

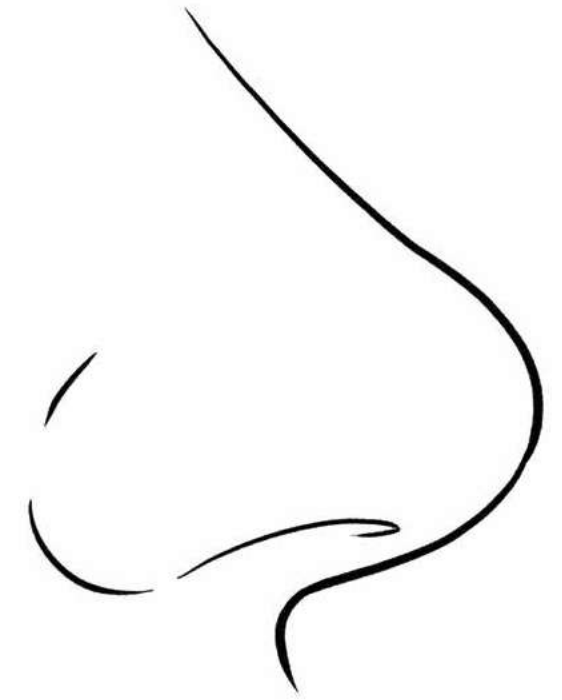
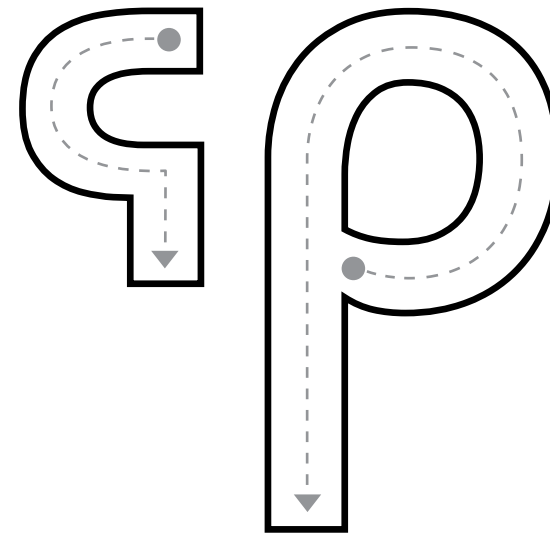

Handwriting practice lines for uppercase letters 'Q' and 'P'. The first row shows a solid letter with stroke order arrows, followed by four dashed letters for tracing, and then five dots on a baseline for independent practice. The second row shows the letters 'Q' and 'P' in Inuktitut syllabics, with the first one solid and the second one dashed for tracing. The third row shows the letters 'Q' and 'P' in Inuktitut syllabics, with the first one solid and the second one dashed for tracing.

